

Narrow Rail Vise Attachment

USERS MANUAL





CHIEF'S LIMITED ONE-YEAR WARRANTY & LIABILITY

Chief Automotive Technologies, Inc. warrants for one year from date of installation and/or purchase any of its products which do not perform satisfactorily due to defect caused by faulty material or workmanship. Chief's obligation under this warranty is limited to the repair or replacement of products which are defective and which have not been misused, carelessly handled, or defaced by repair or repairs made or attempted by others.

CHIEF AUTOMOTIVE TECHNOLOGIES, INC. DOES NOT ASSUME RESPONSIBILITY FOR ANY DEATH, INJURY OR PROPERTY DAMAGE RESULTING FROM THE OPERATOR'S NEGLIGENCE OR MISUSE OF THIS PRODUCT OR ITS ATTACHMENTS. CHIEF MAKES NO WRITTEN, EXPRESS OR IMPLIED WARRANTY WHATSOEVER OF MERCHANTABILITY OR FITNESS FOR A PARTICULAR PURPOSE OR OTHERWISE REGARDING THE EQUIPMENT OR ANY PART OF THE PRODUCT OTHER THAN THE LIMITED ONE-YEAR WARRANTY STATED ABOVE.

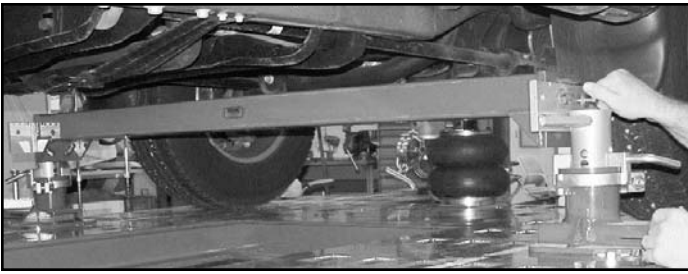

Figure 1

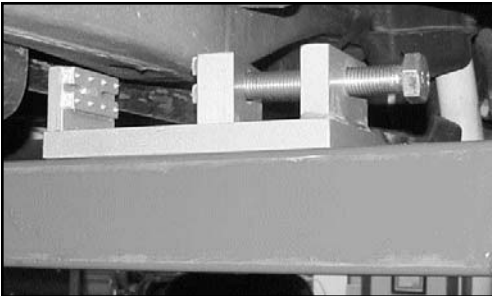

Figure 2

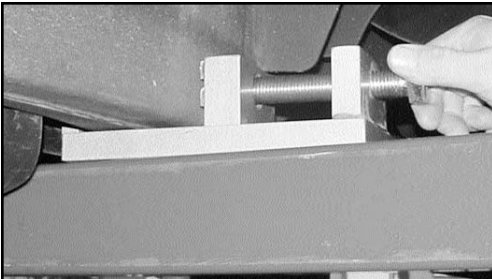

Figure 3

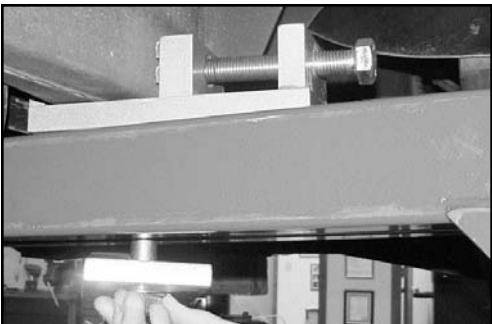

Figure 4

The narrow rail vise attachment fastens to the crossbars of the F.A.S.T Anchoring System and is used to secure box-shaped frame rails. It is primarily used in the front of the vehicle's center section; however, it can be used in the rear of the center section in some applications.

1. Lift end of vehicle where rail vise is to be installed. Lift both sides of vehicle at the same time using Chief Air Jack or other suitable lifting device(s).



CAUTION: If opposite end of center section is not yet anchored, block both wheels at that end of vehicle prior to lifting. Position 4 inch wood blocks at front and rear of each wheel.

2. Install anchoring stands at corners of center section and secure the crossbar of the F.A.S.T. Anchoring System to the stands. (See Figure 1.) Position the bar directly below the boxed rail anchoring locations.
3. Position rail vise on top of the crossbar directly below the boxed rail. (See Figure 2.) If extra height is needed, position appropriate size spacer (or 3 inch riser bar) between crossbar and rail vise. If using the 3 inch riser bar, insert tie back bracket between rail vise and top of riser bar. (See **Special Pulling Situations** — page 2.)
4. Lower vehicle to position boxed rail in jaws of rail vise. Hand-tighten the adjustment bolt to hold the assembly in place. (See Figure 3.)



CAUTION: Keep fingers and hands clear of all contact points.

IMPORTANT: DO NOT use an impact wrench to tighten the rail vise.

5. Secure rail vise to the crossbar using an appropriate length tie down bolt and tie down plate. Insert bolt upward through channel in crossbar and hole in spacer(s) - if installed. Thread the bolt into the base of the rail vise and hand-tighten at this time. (See Figure 4.)
6. Repeat steps 3 - 5 on the opposite side of the vehicle.
7. Install appropriate anchoring equipment at the opposite end of the center section.
8. Firmly tighten all anchoring components.

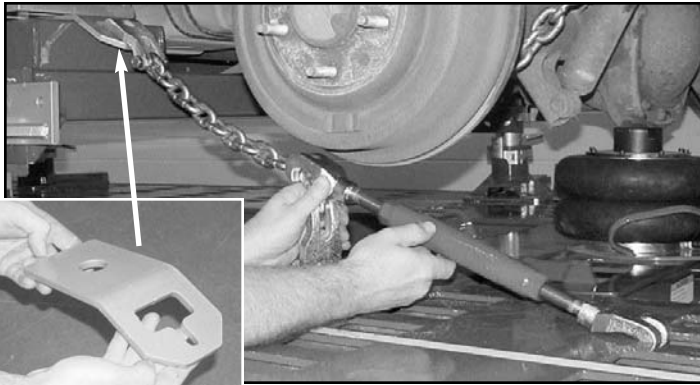

Figure 5

Special Pulling Situations

If one or two of the 3 inch riser bars are installed, provide additional support:

- Insert tie back bracket between rail vise and top riser bar. (See Figure 5 and its Inset.) Then attach a tie down chain to the tie back bracket and use a turnbuckle assist to support the anchoring assembly.

If rail must move with the pull (for example: to correct diamond), make these adjustments on side of vehicle that must move:

- If riser bar is installed, rotate riser bar (top riser bar if two are used) so it straddles the crossbar. (See Figure 6.) Then lower the vehicle to engage attachment with groove in riser bar. **DO NOT** secure attachment to crossbar at this time. This setup allows rail movement across top of riser bar. After the pull is made, secure the attachment to the crossbar.

- If riser bar is not installed, loosen only the tie down bolt securing the anchoring stand to the mainframe. This setup allows the entire anchoring assembly to move with the pull. When the pull is applied use hammer and wood block at base of stand to assist the movement. (See Figure 7.) After the pull is made, firmly secure the anchoring stand to the mainframe.

- If rail configuration is free of obstructions (see Figure 8), loosen only the adjustment bolt on the narrow rail vise attachment. This will allow rail movement through the jaws of the clamp. When the pull is completed, resecure the adjustment bolt.

NOTE: Unfortunately, most rails have various obstructions that would interfere with rail movement through the jaws of the attachment. Figure 8 Inset shows one example of a frame rail obstruction.

CAUTION: DO NOT make pulls to correct diamond until:

1. Rail that 'must not move' is firmly secured at both front and rear anchoring locations.
2. Rail that will move is supported by anchoring equipment and is free to move with the pull.

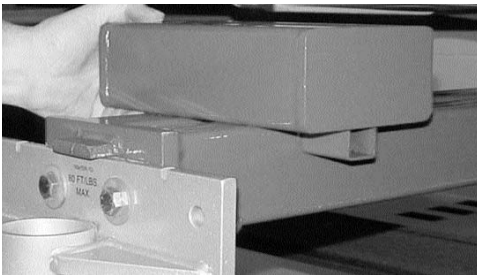

Figure 6



Figure 7

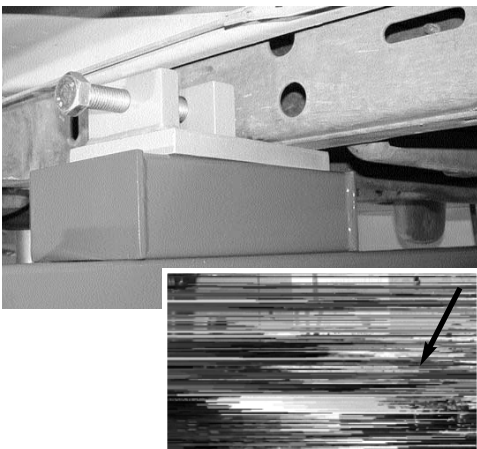
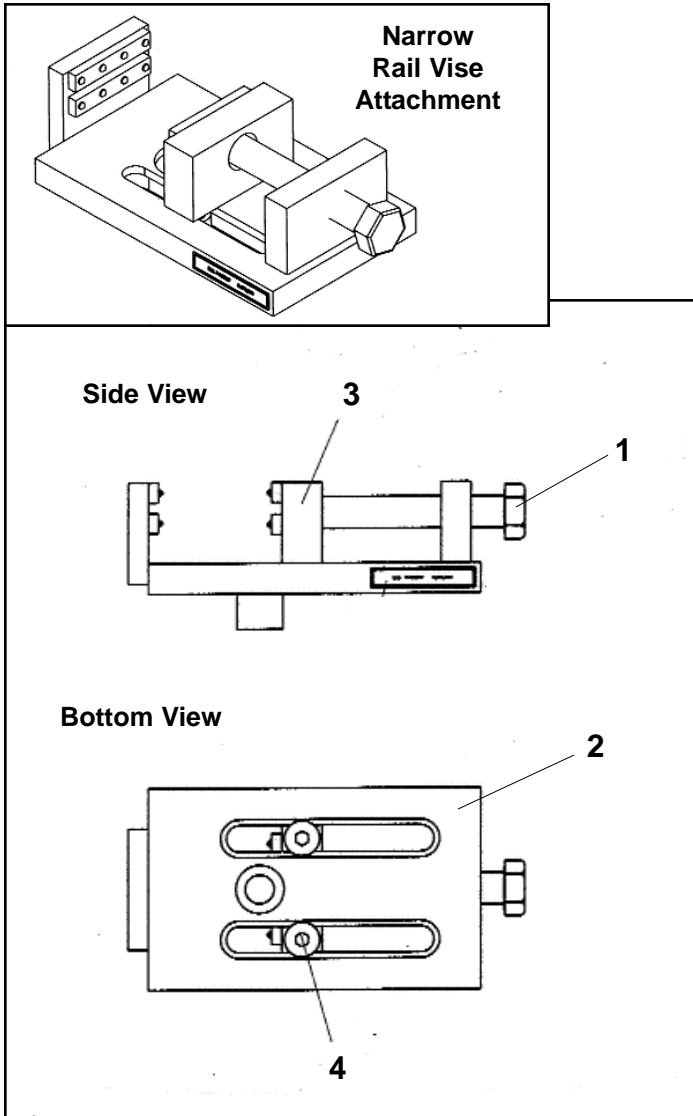

Figure 8



Parts Ordering Information

To order parts for the narrow rail vise attachment or the F.A.S.T. Upgrade Package, contact Chief Automotive Technologies, Inc., 1924 East Fourth Street, Box 1368, Grand Island, Ne. 68802, 800-445-9262. When contacting Chief Automotive Technologies, Inc., provide the following information: name, name of business, telephone number and business address. Additional information needed when ordering includes: a description of the part(s) and part number(s).

Ref	Part No.	Description
	539337	Final Ass'y, Rail Vise Attachment, Complete
1	539010	Bolt, M20 x 2.5 x 120mm
2	539334	Baseplate/Bar assembly
3	539336	Slide Bar/Nail Bar Assembly
4	011081	Shoulder Screw, 5/8, Hex
	539347	Rail Vise Attachment Users Manual

Part No.	Description
200030	F.A.S.T. Anchoring Upgrade Pkg.
539342	Spring Bolt Vise Attach., Set of Two
519730	Anchoring Tool Box
539337	Rail Vise Assembly
539541	Riser Bar, 3 "
539539	F.A.S.T. Tie Back
539630	Turnbuckle Assist, Set of Two
539009	Bolt, M20 x 2.5 x 260mm



P.O. Box 1368
Grand Island, Nebraska 68802-1368
Phone 308-384-9747
Fax 308-384-8966

www.chiefautomotive.com

**Chief reserves the right to alter product specifications and/or
package components without notice.**