

Portable Tower

USERS MANUAL





CHIEF'S LIMITED ONE-YEAR WARRANTY & LIABILITY

Chief Automotive Technologies, Inc. warrants for one year from date of installation and/or purchase any of its products which do not perform satisfactorily due to defect caused by faulty material or workmanship. Chief's obligation under this warranty is limited to the repair or replacement of products which are defective and which have not been misused, carelessly handled, or defaced by repair or repairs made or attempted by others.

CHIEF AUTOMOTIVE TECHNOLOGIES, INC. DOES NOT ASSUME RESPONSIBILITY FOR ANY DEATH, INJURY OR PROPERTY DAMAGE RESULTING FROM THE OPERATOR'S NEGLIGENCE OR MISUSE OF THIS PRODUCT OR ITS ATTACHMENTS. CHIEF MAKES NO WRITTEN, EXPRESS OR IMPLIED WARRANTY WHATSOEVER OF MERCHANTABILITY OR FITNESS FOR A PARTICULAR PURPOSE OR OTHERWISE REGARDING THE EQUIPMENT OR ANY PART OF THE PRODUCT OTHER THAN THE LIMITED ONE-YEAR WARRANTY STATED ABOVE.

INTRODUCTION

This owners manual covers installation and usage procedures for the portable tower assembly which is designed for S21 EZ liner systems and 'Standard' EZ Liner systems.

The portable tower (see Figure 1) allows technicians to make pulls at sides or at rear of machine. It attaches to a pedestal (see Figure 2) that adjusts forward or rearward along inner channels of mainframe. The tower operates from the EZ Liner control switch individually or simultaneously with existing towers and auxiliary rams.

DO NOT attempt to install or operate a portable tower without first reading this entire owners manual. Complete safety information is highlighted throughout the manual and is identified with . This safety alert symbol identifies safety information in the manual and operator injury could result if these CAUTION notes are not followed.

Figure 1



Figure 2

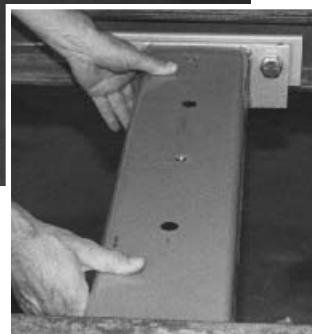

CAUTION:

To prevent personal injury and damage to equipment:

1. Always wear safety glasses during installation and usage of portable towers .
2. DO NOT attempt to install or use portable towers in conjunction with any other repair system. Portable towers are designed solely for S21 EZ Liner systems and for 'Standard' EZ Liner systems.
3. Detach portable towers from EZ Liner system prior to lowering machine.
4. DO NOT use portable tower as a device for moving mainframe.

INSTALLATION

IMPORTANT: If installing this equipment on a S21 EZ Liner system (serial nos. 30007 and higher), proceed with these instructions. If installing this equipment on a 'Standard' EZ Liner system (serial nos. 30006 and lower) first read Pages 7-9.

The pedestal provided with the portable tower can be installed in either the center or rear section of the machine. Although the following procedures reference installation in the rear section, Steps 1 — 7 are also applicable to installation in the center section.

Once installed, the pedestal should not be removed. Additional pedestals are available from Chief Automotive Technologies, Inc. that can be installed either in the same section or an adjoining section of the machine.

 **CAUTION:** Transferring a pedestal from one section to another is time consuming and potentially dangerous if not done carefully and in accordance with installation procedures. It is more productive to maintain pedestals in both the center and rear sections of the machine.

1. Position pedestal on mainframe as shown in Figure 3.
2. Lay mounting tube on top of pedestal and align hole in mounting tube with center hole in pedestal. Place flat washer onto 7 1/2 inch bolt and extend bolt upward through holes in pedestal and mounting tube. (See Figure 4.) Place another flat washer onto the bolt and secure the assembly with 1/2 inch nut. (See Figure 5.)
3. Lift mounting tube and pedestal as shown in Figure 6. Turn the assembly slightly and reposition it on mainframe. (See Figure 7.)
4. Adjust pedestal so it is both perpendicular to and centered between treadways and tighten nut to snug pedestal against bottom of mainframe. (See Figure 8.)
5. Slide mounting brackets into mainframe channels positioning them at ends of pedestal. Secure mounting brackets to pedestal using 3/4 x 1 3/4 inch bolts and 3/4 inch lock washers. (See Figure 9 and its inset.)
NOTE: Holes in mounting brackets are threaded.



Figure 5



Figure 6



Figure 7



Figure 8



Figure 3



Figure 4

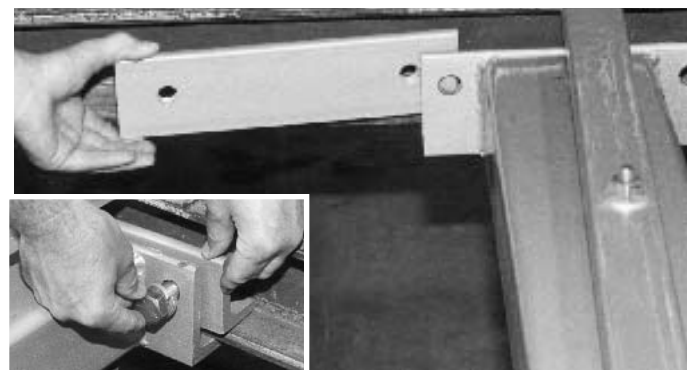

Figure 9

6. Loosen nut and turn mounting tube at slight angle. (See Figure 10.) Loosen mounting bracket bolts and insert shim(s) (if needed) at each end of pedestal. (See Figure 11 and its inset.)

IMPORTANT: Shims must be positioned between mounting bracket and end of pedestal. Use approximately same number of shims on each end of pedestal. Add shims until mounting brackets are within 1/8 inch of channel wall. (See Figure 12.)

7. Retighten mounting bracket bolts and remove mounting tube from the assembly. Slide pedestal forward and rearward throughout mainframe section in which it is installed.

NOTE: If pedestal does not slide forward and rearward with minimal effort, do one or both of the following:

- 1) To gain underside clearance, slightly loosen the four mounting bracket bolts, push downward on pedestal and retighten the four mounting bracket bolts.
- 2) To gain width clearance, loosen mounting bracket bolts on one side, remove one shim and retighten the mounting bracket bolts.

8. Attach knob to collar (see Figure 13) and install 3/8 inch tower chain threading it through collar and looping it across tower head.

CAUTION:

1. Chain links must align with collar roller and fully engage tower head catch. (See Figures 14 and 15.)
2. DO NOT use portable tower's 3/8 inch chain on S21's front towers.

9. Lower collar as far as possible and position tower hook on collar. (See Figure 16.)

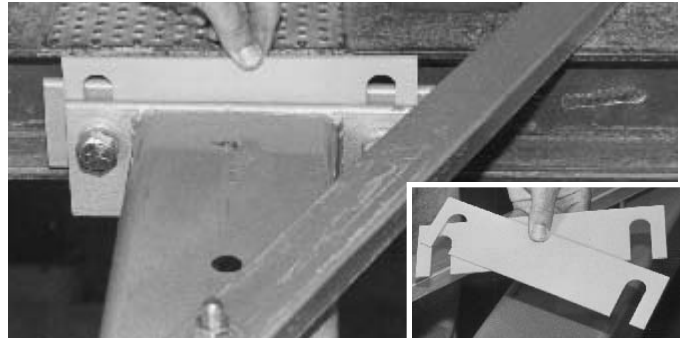

Figure 11



Figure 12

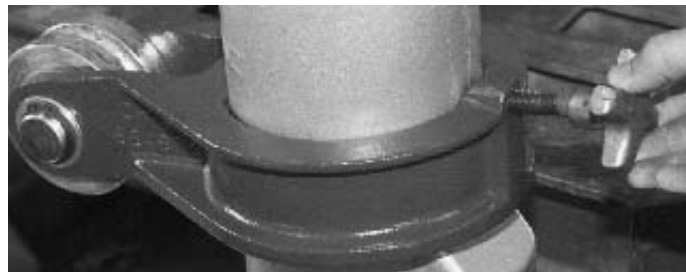

Figure 13



Figure 14



Figure 15

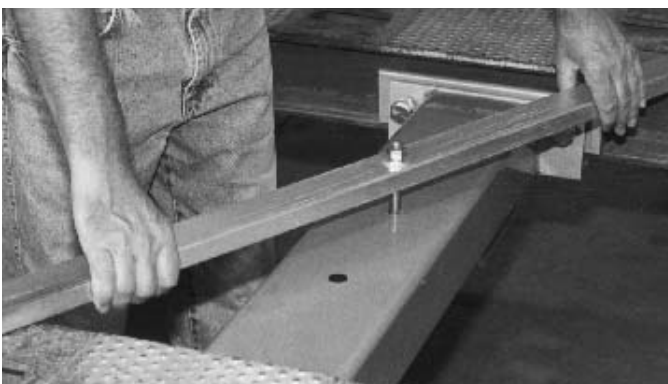

Figure 10



Figure 16

10. Attach EZ Liner's auxiliary hydraulic hose to tower's hydraulic connection.

IMPORTANT:

1. If hydraulic connections are not seated correctly, couplings may leak fluid or may not allow fluid to pass through. Male and female connectors must be fully seated and then tightly threaded together.
2. If existing auxiliary hose is too short, install 190 inch hydraulic hose (Part No. 682806) provided.

CAUTION: After connecting (or disconnecting) hydraulic hose, clean up any hydraulic fluid spillage.



Figure 17

11. Install rear crossmember.

On **Standard machines (serial nos. 30006 and lower)**, refer to page 8.

On **S21 machines (serial nos. 30007-78831)** use a helper to install specially designed crossmember shown in Figure 17.

- a. Position crossmember directly below second row of tie down holes from rear of machine. (See Figure 18.) Crossmember bolts must project upward into tie down holes and crossmember's vertical stops must engage front edge of tie down holes. (See Figure 18 inset.)
- b. Insert 3 x 3 plates into tie down holes and onto crossmember bolts. Attach 3/4 inch nuts and washers provided and tighten to 100 foot pounds of torque.

IMPORTANT: Rear permanent crossmember must be used only for pinning portable tower.

On **S21 machines (serial nos. 78832 and higher)** install movable crossmember at rear of machine and secure with crossmember locks. Slide crossmember forward as far as locks will permit to prevent movement during the pull. (See Figure 19.)

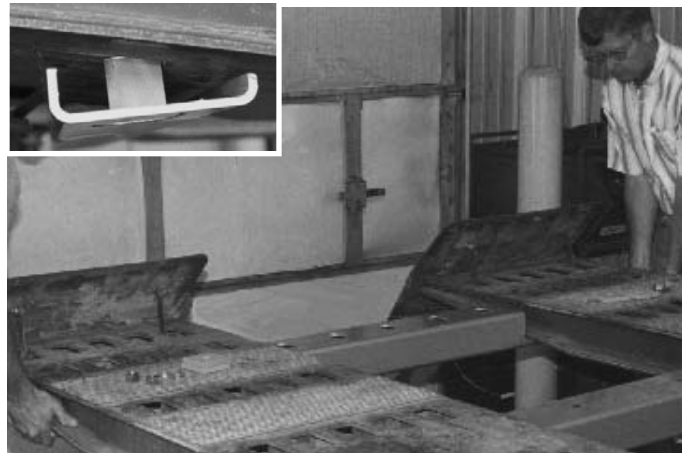

Figure 18

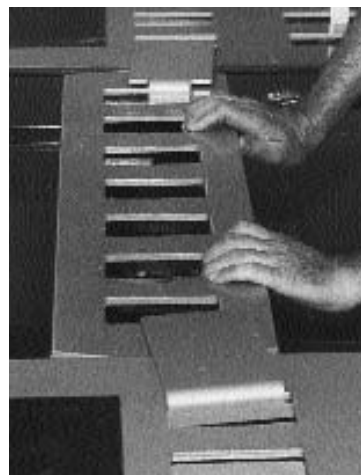

Figure 19

12. Affix CAUTION label to outer channel of mainframe next to lift valve cover and above rear stiff leg. (See Figure 20.)



Figure 20

13. Position tower arm under mainframe at various locations along sides and at rear of machine. At each location, measure gap between pinning plate and bottom of mainframe.
- If narrowest gap exceeds 1/4 inch, add shim(s) to each of the tower's rear caster assemblies until gap is 1/4 inch or less. To add shims:
 - a. Lift tower's rear wheels off floor (see Figure 21) using tie down bolt installation procedure. (See Step 3 — Page 6.)
 - b. Remove caster assemblies, insert shim and reassemble. If additional shims are needed, contact Chief Automotive Technologies, Inc. 800-445-9262.
 - If pinning plate rubs or scrapes bottom of mainframe or crossmember (see Figure 22), add washer to pivot pin assembly (see Figure 22 inset). Then reassemble pivot pin assembly and reposition tower. If additional clearance is needed, add a second washer.

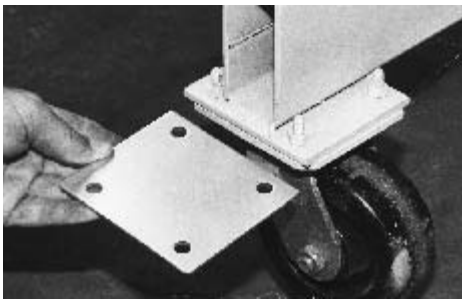

Figure 21



Figure 22

USAGE

IMPORTANT: If using this equipment on an S21 EZ Liner system (serial nos. 30007 and higher) proceed with these instructions. If installing this equipment on a 'Standard' EZ Liner system (serial nos. 30006 and lower), first read Pages 7-9.

Many of the usage procedures and safety precautions for S21 front towers also apply to portable towers —

see Towers, EZ Liner Owners Manual. In addition, there are usage procedures and safety precautions that apply specifically to portable towers. These are included in this manual.

NOTE: Pulling capacity of S21 portable towers is less than S21 front towers. Portable towers house a 5 ton hydraulic cylinder (8 inch stroke) and front towers house a 10 ton hydraulic cylinder (10 inch stroke).

CAUTION:

1. DO NOT use portable tower chain (3/8-12 with hook) on S21 front towers. S21 front towers require 1/2-12 tower chain with hook.
2. DO NOT use pedestal as a step.
3. DO NOT allow portable tower to come in contact with rear stiff leg assembly.

1. Position Pedestal on mainframe.

NOTE: For best results, position Pedestal so its housing is under or approximately under the pulling point on vehicle.

- If tower is positioned at side of mainframe, install pedestal locks to prevent pedestal movement. Use two locks if pedestal is positioned between rows of tie down holes and one lock if it is in line with row of tie down holes. (See Figures 23 and 24.) A slight fore/aft adjustment of pedestal may be required so that locks fully engage tie down holes. (See Figure 23 inset.)
- If tower is positioned at rear of machine (behind safety ramps or rear permanent crossmember), DO NOT install pedestal locks. Pedestal need only be positioned far enough inward to allow tower pinning plate to align with tie down holes on rear permanent crossmember.

IMPORTANT: When winching vehicle on and off mainframe, DO NOT roll dead vehicle dollies over pedestal locks.



Figure 23



Figure 24

2. Attach tower to housing on pedestal by inserting tower pivot pin (see Figure 25) into housing and securing it with pin and clip (see Figures 26 and 27.).

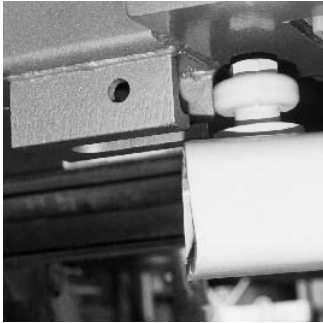

Figure 25



Figure 26



Figure 27

3. Align tower as per pull required and secure it to outer tie down hole on mainframe or to hole on rear permanent crossmember. Use tower pin if pull can be made within 45 degree range shown in Figure 28. Use tie down bolt when pulling outside this range, or when pulling upward within 60 degree range shown in Figure 29.

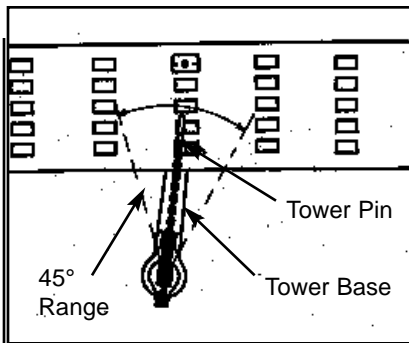

Figure 28

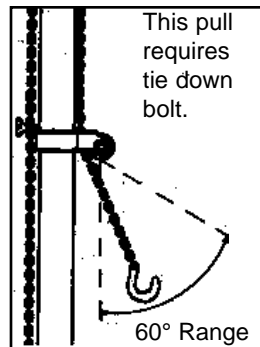

Figure 29

Tower pin must project through tie down hole on mainframe (or rear permanent crossmember) and fully engage hole on tower pinning plate. (See Figures 30 and 31.) If pull causes tower to lean, use shim(s) to fill gap between pinning plate and bottom surface of mainframe. (See Figure 32.)

Tie down bolt must project through 3 1/2 x 4 inch tie down plate, tie down hole on mainframe (or rear permanent crossmember) and hole on tower pinning plate. Use 3/4 inch nut and flat washer to secure tower to mainframe. (See Figure 33.)



Figure 30



Figure 31



Figure 32

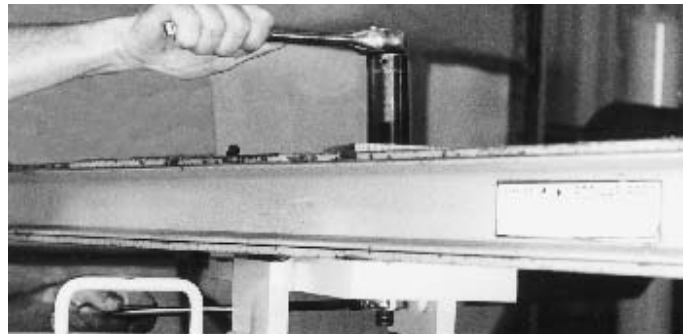

Figure 33

Ramp Adjustments / Removal are required when moving tower past end of treadway or when making pull from behind end of treadway.

If machine is equipped with 'safety ramps' (older style S21s and Standard machines), secure ramp in upright position when moving tower past ramp or when pulling from behind ra,. Use ramp support if machine design allows (see Figure 34) or use a chain (with chain hooks) if it doesn't (see Figure 35).

CAUTION:

- 1. Use ramp support or chain only when moving tower past ramp or when making pull from behind ramp.
- 2. Always remove ramp support or chain when tower is moved.
- 3. DO NOT raise or lower machine with ramp support or chain installed.



Figure 34



Figure 35

If machine is equipped with 'portable loading ramps' (newer style S21s), remove ramp (see Figure 36) when moving tower past end of treadway or when pulling from behind end of treadway. Replace loading ramp when tower is moved from end of treadway.

⚠ CAUTION:

1. Remove portable loading ramp only when it interferes with tower movement or tower pull at end of machine treadway.
2. Replace portable loading ramp as soon as tower is moved from end of treadway.

4. Adjust tower collar and chain as per pull required. See Towers — S21 EZ Liner Owners Manual.

CAUTION:



1. DO NOT exceed 6500 PSI (448 bar) hydraulic pressure when collar assembly is positioned 18 inches (457mm) or less from top of tower pipe. (See Figure 37.)
2. DO NOT use portable towers to make pulls until vehicle is secured to EZ Liner mainframe with appropriate anchoring equipment. DO NOT use portable towers to anchor vehicle to mainframe.

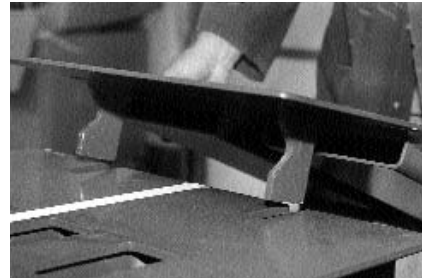

Figure 36

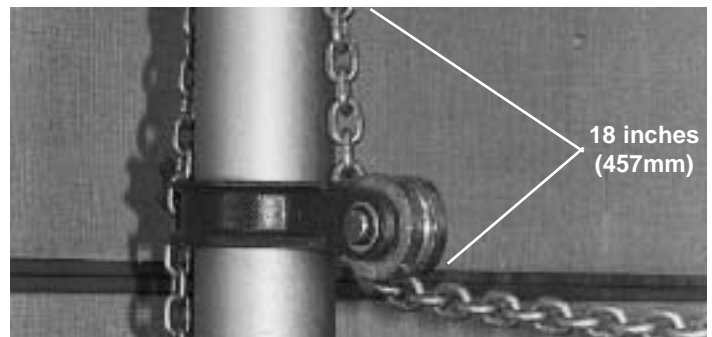

Figure 37

'STANDARD' EZ LINER APPLICATIONS

Although installation and usage of portable towers on 'Standard' EZ Liners is similar to installation and usage of portable towers on S21 EZ Liners, there are some notable differences. For example, installation of portable towers on 'Standard' EZ Liners requires installation of a different length pedestal and a modified rear crossmember.

PEDESTAL

Portable Tower usage on a 'Standard' EZ Liner requires installation of a long 'white' pedestal in rear section of machine. This pedestal can also be used in center section of machine provided a mainframe extension kit was not previously installed. The extension kit narrows the center section and requires that a 'short' white pedestal be installed.

Pedestal installation is identical to S21 procedures (see Pages 1-3) with two exceptions:

- When locking the short, white pedestal to mainframe extension kit, pedestal must be positioned between rows of tie down holes and secured with two pedestal locks on each side of mainframe. (See Figure 38.)

- When making pulls at end of machine (behind and/or between ramps), pedestal must be in line with third row of tie down holes from rear of machine and secured with one pedestal lock on each side of mainframe. (See Figure 39.)

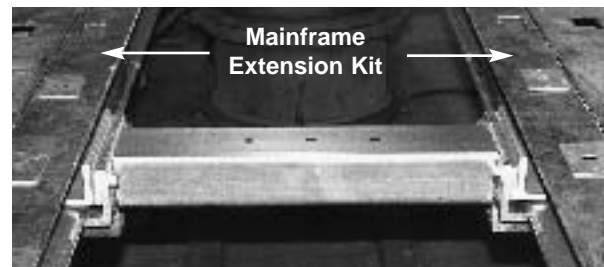

Figure 38

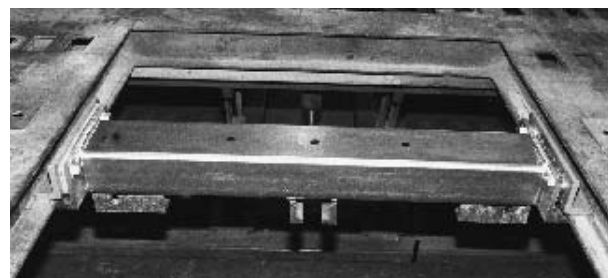

Figure 39

REAR CROSSMEMBER

To install rear crossmember on 'Standard' EZ Liners, follow these procedures:

1. If machine is equipped with safety ramps, remove ramps from machine. If it is not equipped with ramps, proceed to Step 2.
2. Slide rear crossmember onto mainframe (from rear of machine — see Figure 40) and position it on traction plates between first and second row of tie down holes.
NOTE: Rear edge of crossmember should be positioned on treadway plate as shown in Figure 40 Inset.
3. Tighten crossmember's mounting bolts (see Figure 41) to approximately 80 foot pounds of torque.
4. Reinstall safety ramps.

IMPORTANT: If machine is not equipped with safety ramps, it will be necessary to remove rear crossmember each time machine is lowered. If rear crossmember is not removed, it will prevent mainframe from reaching the floor.

TOWER

The 'Standard' EZ Liner has a slightly higher mainframe than the S21. To accommodate this difference, portable tower legs are extended. (See Figure 42 which shows steel tubing installed between caster assembly and bottom of tower leg.)

Technicians may add an additional 1/4 inch shim to each of the tower's rear legs if gap between tower pinning plate and bottom of mainframe exceeds 1/4 inch at any point around the machine. (See Step 13 — Page 5.) If tower pinning plate rubs or scrapes bottom of mainframe at any point around the machine, technician may need to add a washer (spacer) to tower pivot pin assembly. (See also Step 13 — Page 5.)

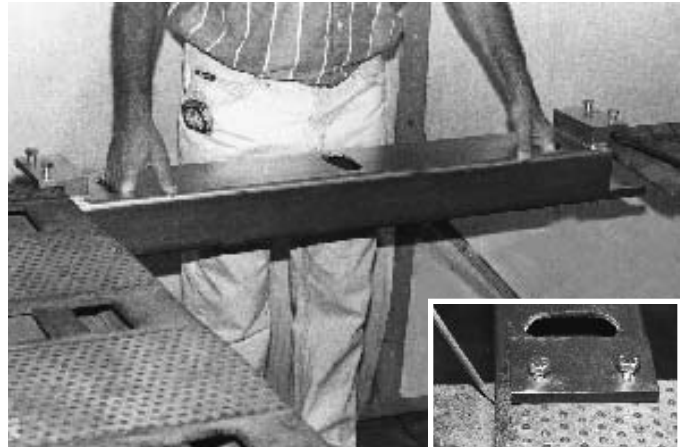

Figure 40

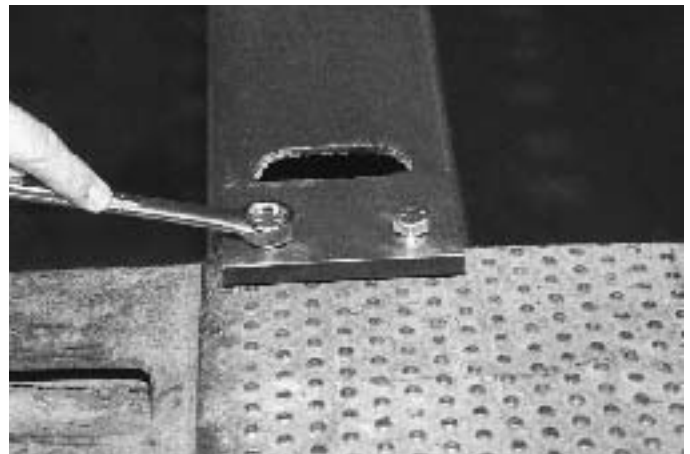

Figure 41

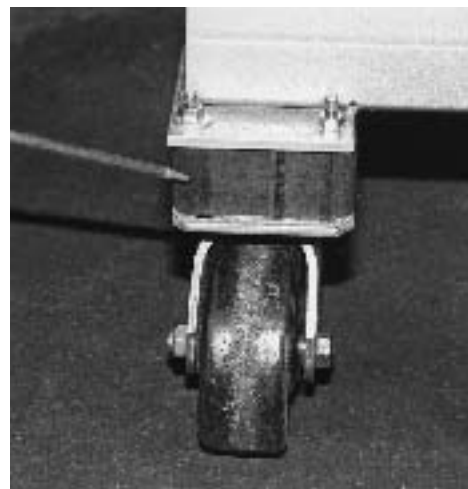

Figure 42

PINNING/BOLTING

When using portable tower at rear of machine, follow bolting/pinning recommendations on Page 6.

NOTE: If it is difficult to pin or bolt tower through tie down holes in rear crossmember, adjust fore/aft position of crossmember (see Figure 43) to allow tower pin or tower bolt to drop into hole on pinning plate. After repositioning crossmember, retighten its mounting bolts to approximately 80 foot pounds of torque.

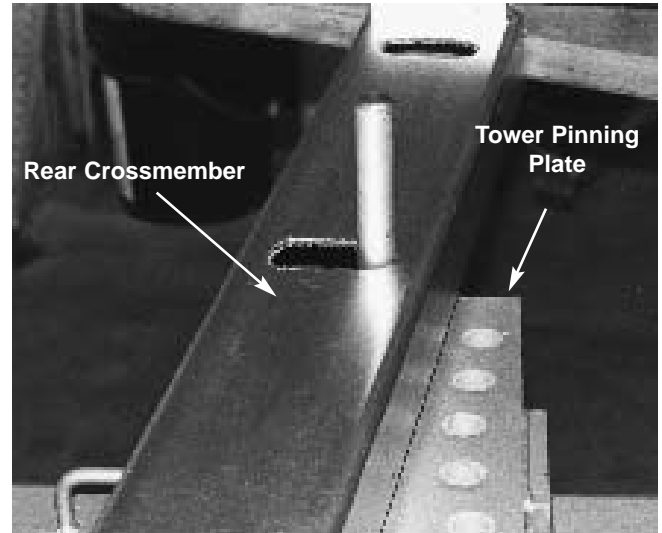

Figure 43

ACCESSORY APPLICATIONS

An auxiliary ram can be used on top of the portable tower pedestal provided it is positioned in a ram base (Part No. 611303) (see Figure 44) and provided it is only used to push upward.

A Chief down pull attachment (Part No. 772086) can be used on top of portable tower pedestal (see Figure 45) provided it is used as per instructions supplied with that accessory.

CAUTION: DO NOT use auxiliary ram or down pull attachment on rear permanent crossmember.



Figure 44



Figure 45

PARTS INFORMATION

To order replacement parts for portable tower or its pedestals and crossmember, contact Chief Automotive Technologies, Inc. 800-445-9262. (If outside United States, contact nearest Chief Automotive Technologies, Inc. representative.)

When contacting Chief Automotive Technologies, Inc. by telephone or mail, provide the following information: name, name of shop, shop telephone number, shop address, description of part(s), and part number(s).

| REF. | PART NO. | DESCRIPTION |
|------|----------|---|
| | 600550 | Single Rear Tower and Pedestal* for Standard, Serial Nos. 30006 and lower. |
| | 600551 | Dual Rear Tower and Pedestal* for Standard, Serial Nos. 30006 and lower. |
| | 600539 | Optional Center Pedestal* (Long) for Standard, Serial Nos. 30006 and lower. |
| | 600540 | Optional Center Pedestal* (Short) for Standard, Serial Nos. 30006 and lower. |
| | 600510 | Single Rear Tower and Pedestal* for S21, Serial Nos. 30007-67975. |
| | 600512 | Dual Rear Tower and Pedestal* for S21, Serial Nos. 30007-67975. |
| | 600511 | Optional Center Pedestal* for S21, Serial Nos. 30007-67975. |
| | 600514 | Single Rear Tower and Pedestal* for S21, Serial Nos. greater than 67975. |
| | 600515 | Dual Rear Tower and Pedestal* for S21, Serial Nos. greater than 67975. |
| 1 | 532097 | Caster Spacer |
| 2 | 706847 | Nut, 5/16-18NC, Hex, Sems, Keps, Pl. |
| 3 | 756529 | Cap, Screw, 5/16-18NC x 1 1/4, Lg. Serrated |
| 4 | 092443 | Caster, Swivel, 5" |
| 5 | 620269 | Hairpin |
| 6 | 770091 | Lock Pin, 1 1/4 Dia. x 9 1/4 |
| 7 | 600506 | Tower Assembly for S21 Serial Nos. 30007-67975, (Complete) |
| 8 | 770108 | Tower Pivot Pin |
| 9 | 770074 | Bolt, 1-8NC x 4 1/2, Hex, Gr. 8, Pl. |
| 10 | 600452 | Spacer, Spring |
| | 770072 | Compression Spring, 1.5 dia. x 5.54 Long |
| 11 | 600470 | Tower Pin |
| | 682953 | EZ Liner Tie Bolt Plate |
| | 770149 | Bolt, 3/4 x 8", Gr. 5, Pl. |
| | 601720 | Nut, 3/4-10, Hex, Gr. 8, Pl. |
| | 601738 | Washer, 3/4 x 1 1/2", Flat, Pl. |
| 12 | 690793 | Tower Collar Assembly (Complete) |
| | 689858 | Auxiliary Ram Assembly (Complete) |
| | 604939 | Quick Coupler, Female End |
| 13 | 690611 | Tower Head |
| 14 | 785206 | Tower Chain W/Hook, 3/8" x 12' |
| 15 | 600509 | Rear Permanent Crossmember Assembly for S21 — Serial Nos. 30007-67975, (Complete) |

| REF. | PART NO. | DESCRIPTION |
|------|----------|---|
| 16 | 603266 | Plate, 1/2 x 3 x 3" |
| 17 | 770147 | Washer, 1", Int. Tooth Lock |
| 18 | 770142 | Nut, 1-8NC, Hex, Gr. 8, Pl. |
| 19 | 600507 | Pedestal Weldment, Silver, for S21 Serial Nos. greater than 30007 |
| 20 | 600462 | Angle, Bolt On, Pedestal |
| 21 | 600463 | Shim, 1/8" |
| 22 | 692810 | Bolt, HHCS, 3/4-10NC x 1 3/4", Gr. 8, Pl. |
| 23 | 707444 | Lock Washer, 3/4" |
| 24 | 600508 | Pedestal Lock |
| 25 | 600473 | Mounting Tube |
| 26 | 010644 | Bolt, 1/2-13 x 7 1/2" HHCS, Gr. 8, Pl. |
| 27 | 620736 | Nut, 1/2-13NC, GR. 8, Hex, Pl. |
| 28 | 019095 | Washer, 1/2"-A325 ZP |
| | 770158 | Decal, CAUTION, 'Always Push' |
| | 600475 | Decal, CAUTION, 'Remove Portable' |
| | 682770 | Label, CAUTION, 6500 PSI |
| | 600476 | Decal, CAUTION, 'Safety' |
| | 693337 | Label, WARNING, 'DO NOT Position' |
| | 683630 | Decal, Chief EZ Liner |
| 29 | 600535 | Tower Assembly for 'Standard' — Serial Nos. 30006 and lower, (Complete), Same as Part No. 600506 plus height extensions |
| 30 | 600531 | Rear Permanent Crossmember Assembly for 'Standard' — Serial Nos. 30006 and lower, (Complete) |
| | 010624 | Bolt for Rear Permanent Crossmember, (Standard) 1/2 - 13 x 1 |
| 31 | 600530 | Pedestal Weldment, White, Short, for 'Standard' With Extension Kit |
| 32 | 600532 | Pedestal Weldment, White, Long, for 'Standard' — normal width. |
| 33 | 689848 | Ramp Support |
| 34 | 532071 | Shim - Brace, Short, Mount (B) |
| 35 | 610773 | Portable Crossmember, S21 (Serial No. greater than 67975) |
| 36 | 606539 | Portable Crossmember Lock, S21 |

* **Pedestal must be installed by authorized Chief Service Representative.**

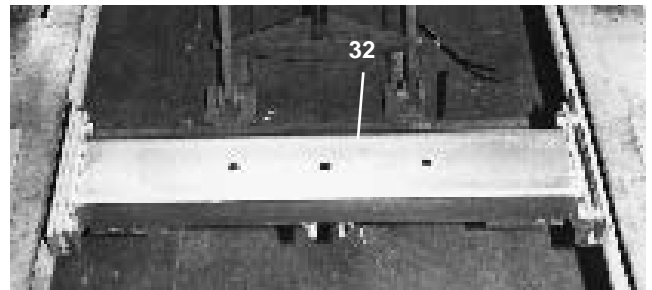
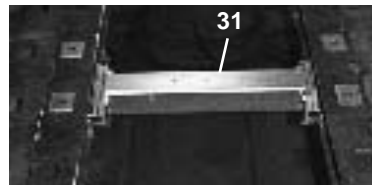
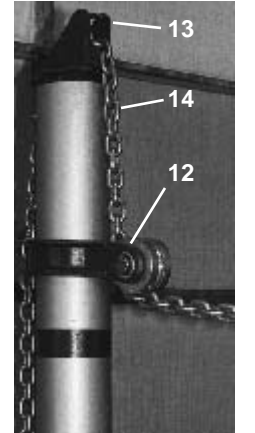
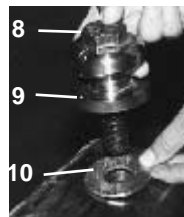
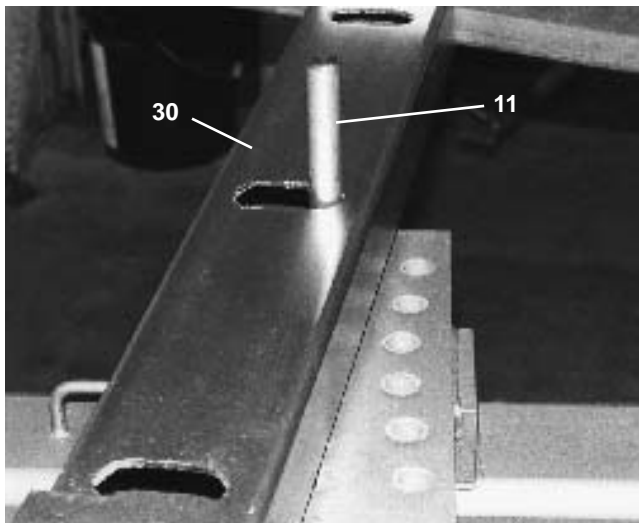
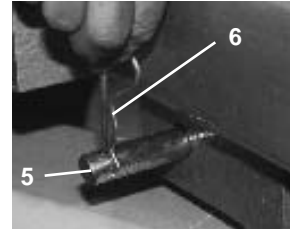
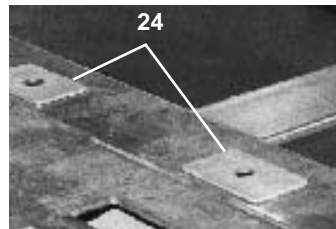
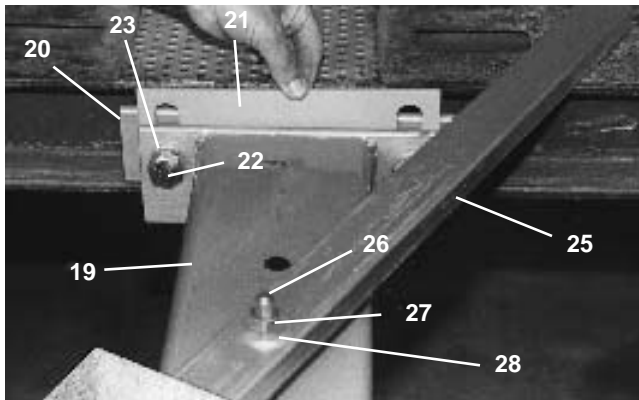
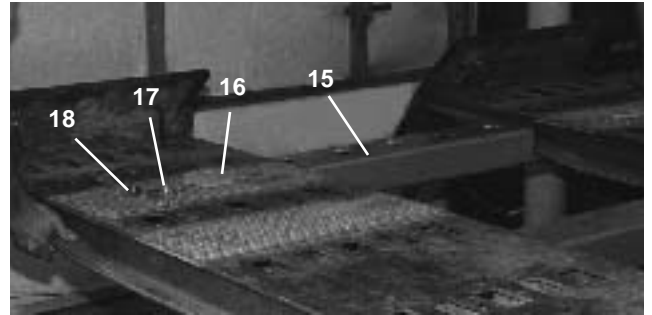
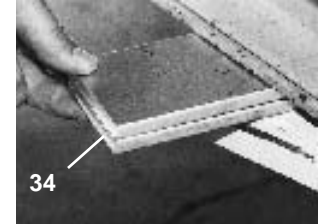
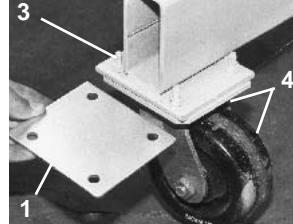
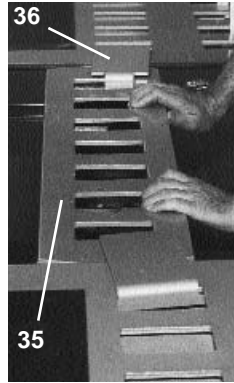
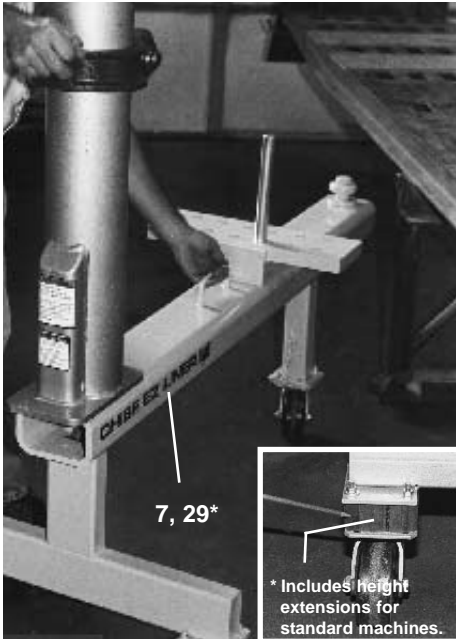



P.O. Box 1368
Grand Island, Nebraska 68802-1368
Phone: 308/384-9747
Fax: 308/384-8966

www.chiefautomotive.com

**Chief reserves the right to alter product specifications
and/or package components without notice.**