



# Operating Manual

## **MULTISPOT MI-100**

### Resistance Welder



Item no. 327519  
Revision: 3.0 - Translation  
Version: 24<sup>th</sup>, March 2009

**Be sure you have read and understood this operating manual before you carry out any works on and/or with this equipment.**

© ELEKTRON-BREMEN  
Elektrotechnik GmbH  
Am Hohentorshafen 17-19  
28197 Bremen - Germany

Phone: +49 (0) 54 90 6-906  
Fax: +49 (0) 54 90 6-19

Email: [vertrieb@elektron-bremen.de](mailto:vertrieb@elektron-bremen.de)  
Web: [www.elektron-bremen.de](http://www.elektron-bremen.de)

Release:

Elektron-Bremen

---

<b>1.</b>	<b>General Information .....</b>	<b>5</b>
1.1	Information concerning the operating manual .....	5
1.2	Copyright .....	5
1.3	Symbols .....	5
1.4	Disclaimer .....	6
1.5	Warranty and guarantee .....	6
1.6	Customer service .....	6
<b>2</b>	<b>Health and safety .....</b>	<b>7</b>
2.1	Intended purpose .....	7
2.2	Responsibilities of the operating company .....	7
2.2.1	General responsibilities .....	7
2.2.2	Requirements to personnel .....	8
2.2.3	Personal protective equipment (PPE) .....	9
2.3	Particular dangers .....	10
2.3.1	Dangers due to the equipment .....	10
2.3.2	Dangers due to the work environment .....	11
2.3.3	Dangers to this equipment and other property .....	11
2.4	Correct behaviour in accidents and dangerous situations .....	12
2.5	Measures to be taken in case of work at the device .....	12
2.6	Safety devices .....	13
2.7	Safety labels and markings on this equipment Fehler! Textmarke nicht definiert. ....	13
2.7.1	On the flap cover .....	13
2.7.2	Signs on the backside .....	14
2.7.3	On the balancer .....	14
2.8	Spare and wear parts .....	14
2.9	Waste management and environmental protection .....	15
<b>3</b>	<b>Transport, packaging, storage .....</b>	<b>16</b>
3.1	Safety during transport .....	16
3.2	Symbols on packaging .....	16
3.3	Unpacking .....	16
3.4	Acceptance after shipping .....	16
3.5	Handling .....	17
3.5.1	Forklift truck .....	17
3.5.2	Transport with belts .....	17
3.5.3	Moving equipment to the site .....	17
3.6	In case of return of goods / further transport needs .....	18
3.7	Storage .....	18
<b>4</b>	<b>Design and functionality .....</b>	<b>19</b>
4.1	Overview .....	19
4.2	Description .....	19
4.3	Display and control elements .....	20
4.3.1	On the display and control panel .....	20
4.3.2	On the inverter control unit .....	20
4.4	Connections .....	20
4.4.1	Connections on the front side .....	20
4.4.2	Connections on the backside .....	21
4.5	Accessories .....	22
4.5.1	Scope-of-delivery accessories .....	22
4.5.2	Optional accessories .....	22
4.5.3	Tools required .....	22
<b>5</b>	<b>Installation .....</b>	<b>23</b>
5.1	Before installation .....	23
5.1.1	Preliminary works .....	23

---

5.2	Filling up cooling water tank .....	23
5.3	Assembling the balancer .....	24
5.4	Electrical connections .....	25
5.5	Connecting the pneumatics .....	26
5.6	Connecting the pliers .....	27
5.7	Connecting the welding gun .....	28
<b>6</b>	<b>Operation.....</b>	<b>29</b>
6.1	Preliminary works before welding.....	29
6.1.1	Preparing the sheets.....	29
6.1.2	Preparing welding pliers .....	29
6.1.3	Checks before switching on.....	31
6.2	Switching on .....	32
6.3	Bedienung über Tastatur .....	32
6.4	Important information concerning welding.....	33
6.5	Operating the welding gun.....	36
6.5.1	Push spot welding.....	36
6.5.2	Pulling-out dents with washer .....	37
6.5.3	High-speed planishing hammer „SAH“ (special accessory) .....	38
6.5.4	Pushing-in dents .....	39
6.5.5	Shrinking sheet .....	39
6.5.6	Welding-on threaded studs.....	40
6.5.7	Welding-on T-pins.....	41
6.5.8	Fixing sheet metal parts (tacking).....	42
6.5.9	Water-cooled spot welding gun (special accessory) .....	42
6.5.10	Connection of Airpuller/ Dentpuller .....	42
<b>7</b>	<b>Troubleshooting .....</b>	<b>43</b>
7.1	Health and safety during troubleshooting .....	43
7.2	Error messages and troubleshooting tables.....	43
7.2.1	Problems displayed on the control panel.....	43
7.2.2	Possible causes and remedies in case of unsatisfactory welding results .....	43
<b>8</b>	<b>Maintenance.....</b>	<b>44</b>
8.1	Maintenance schedule.....	44
8.2	Carrying out maintenance jobs.....	44
8.2.1	Cleaning.....	45
8.2.2	Maintaining the pneumatic unit .....	45
8.2.3	Replacing water filter .....	46
8.2.4	Empty cooling water tank.....	47
8.3	Measures to be taken after maintenance .....	47
<b>9</b>	<b>Specifications .....</b>	<b>48</b>
9.1	Dimensions and weights.....	48
9.2	Power requirements.....	48
9.3	Supplies .....	48
9.4	Working conditions .....	48
9.5	Exposure limit values.....	49
9.6	Type plates .....	49
<b>10</b>	<b>Index .....</b>	<b>50</b>
<b>11</b>	<b>Appendix .....</b>	<b>52</b>
	Training Report.....	52

## 1. General Information

### 1.1 Information concerning the operating manual

This operating manual will enable you to work efficiently and safely with this equipment. The manual is an essential part of this product and must be stored ready at hand not far from the equipment so that people can use it at any time without any problems. Operators must read and understand the manual before they carry out any works. Compliance with any and all information contained herein concerning health, safety and safe behaviour and procedures is a prerequisite for safe work.

Shall apply in addition: any and all local accident prevention regulations, any and all general safety regulations that may apply to the scope of application of this equipment.

Pictures, drawings etc. contained in this operating manual are supposed to convey a general understanding of facts. In details, they may deviate from the reality you encounter.

Besides this operating manual, there may be specific instructions for units, components etc. They shall apply accordingly.

### 1.2 Copyright

This operating manual is protected by copyright. It may be used for internal purposes, exclusively. The manual and/or its contents may not be relinquished to third parties and/or communicated, processed, used and/or reproduced in any way or form whatsoever (not even in excerpts and/or for internal purposes) without the prior written consent of the manufacturer.

Contravention shall entail damage claims.





All other rights reserved.

### 1.3 Symbols

Safety information

This manual uses symbols to highlight important safety information. In addition, there is always a signal word heading the information indicating the severity of the danger or hazard that may be encountered.

Be sure to comply with any and all safety information. Proceed with care and circumspection. Prevent accidents and damage to people and property.

	<p><b>DANGER</b> ... indicates a situation that is imminently dangerous and will entail the death of people and severe injuries unless it is properly avoided and prevented.</p>
	<p><b>WARNING</b> ... indicates a situation that may become dangerous and may entail the death of people and severe injuries unless it is properly avoided and prevented.</p>
	<p><b>CAUTION</b> ... indicates a situation that may become dangerous and may entail medium and small injuries unless it is properly avoided and prevented.</p>
	<p><b>CAUTION</b> ... indicates a situation that may become critical and may entail damage to property unless properly avoided and prevented.</p>

## General Information

---

### Tips, tricks and recommendations

**NOTE!**

*... highlights information that may be helpful to maintain efficient and troublefree operation.*

## 1.4 Disclaimer

Any and all information contained in this operating manual has been written on the basis of pertinent standards and regulations, the state of the art, and the long-standing insights and experience of our staff.

The manufacturer cannot be made liable for damage due to:

non-compliance with this operating manual

non-compliance with the purpose and intent of this equipment

deployment of unskilled personnel

unauthorised constructional changes, alterations etc.

unauthorised changes, modifications etc. to design and engineering etc.

use of unauthorised spare and wear parts

The scope of the delivery you actually receive may deviate from explanations and/or representations in this manual - if and when you ordered special options, your equipment is a special design and/or technical progress facilitates improvements.

Shall apply: any and all obligations and stipulations of the Delivery Contract, the General Terms of Business and Terms of Supply and Delivery of the manufacturer as well as any and all legal stipulations and regulations in force on the day the Contract was concluded.

We constantly strive to further develop and improve our products and their functionality. We, therefore, reserve the right to implement technical changes without notice.

## 1.5 Warranty and guarantee

The guarantee conditions shall be as stipulated in the General Terms of Business of the manufacturer.

## 1.6 Customer service

Our customer service will be happy to provide technical support. For contact information, → see page 2 of this manual.

Please note: Our staff is always eager to learn about new information, insights and/or experience our customers may derive from the work with our products that may be helpful for their future improvement.

## 2 Health and safety

This section contains an overview of the most important health and safety at work aspects in order to protect employees and to guarantee safe and troublefree operation.

Non-compliance with any and all of the information, safe behaviour and procedures etc. contained herein may entail severe health and safety risks.

### 2.1 Intended purpose

This equipment has been designed and built for the following purpose(s), exclusively, and shall be used accordingly:

The **MULTISPOT MI-100** resistance welder serves the sole purpose of spot welding during maintenance work on car bodies, for stock of up to 3 mm sheet gauge and combinations of up to three sheets within its specifications and limits of use (→ see "Specifications").

"Intended use" and "intended purpose" shall include proper compliance with any and all information contained in this operating manual.

Any and all use diverting from and/or going beyond the limits as set by the equipment's intended purpose and use shall be deemed misusive and may entail dangerous situations.



#### **WARNING ! Misuse may entail danger**

Misuse of this equipment may entail dangerous situations. Therefore:

- Do not operate this equipment unless clearly within its specs and limits of use (→ see "Specifications").
- Be sure to use this equipment for welding sheet metal up to 3 mm, galvanised stock and sheets made of super speed steel (HSS), exclusively.
- Do not misuse this equipment for heating, thawing or perhaps even igniting objects.
- Do not use this equipment in explosive atmospheres.
- Do not open, alter, modify and/or manipulate etc. this equipment.

The manufacturer shall not be held liable for any and all damage due to misuse of this equipment.

### 2.2 Responsibilities of the operating company

#### 2.2.1 General responsibilities

This equipment has been designed for professional use. The owner/operator or operating company therefore being a businessman or commercial company, they are subject to any and all legal obligations concerning health and safety at work.

That means, in addition to this operating manual, any and all accident prevention, health and safety at work and environmental regulations pertaining to this equipment's scope of application shall apply as well. This means in particular:

- The operating company must be informed about any and all pertinent health and safety at work regulations and must carry out a risk assessment in order to determine additional hazards existing under the specific conditions in the specific work environment at the place of operation. Any and all findings from such a risk assessment must then be used to draw up additional operating instructions for the operation of this equipment.
- During the entire lifetime of this equipment, the operating company must check in regular intervals whether such additional operating instructions are still up to date and must update them when necessary.
- The operating company must unambiguously determine and communicate responsibilities concerning the installation, operation, maintenance and cleaning of this equipment.



## Health and safety

- The operating company must make sure that any person handling this equipment has read and understood this operating manual. Operating personnel, in addition, must be trained in regular intervals and must be informed about the dangers existing in connection with this equipment. (For a draft of a training report form, see "Appendix")
- The operating company must equip operating personnel with suitable personal protective equipment (PPE) and check it for proper working condition in regular intervals. Defective PPE must be replaced with new ones.
- The operating company must take appropriate and suitable fire protection measures and make available fire extinguishers and first aid kits.

The operating company is responsible that the equipment is in proper working order at all times. Therefore:

- The operating company must make sure that any and all maintenance jobs described in this manual are really carried out.
- The operating company must have any and all safety labels, markings etc. on the equipment checked for integrity and readability in regular intervals.

### Symbols the operating company must install on access ways and doors

Symbol	Meaning
	Electromagnetic fields – hazard to persons with pacemakers. Persons who may suffer health risks due to the influence of electromagnetic fields must not approach this equipment.
	Electromagnetic fields – hazard to persons with magnetisable implants. Persons who may suffer health risks due to the influence of electromagnetic fields must not approach this equipment.

### Symbols the operating company must install in the immediate vicinity of the equipment

Symbol	Meaning
	Electromagnetic fields – hazard to magnetisable objects Magnetisable data carriers and similar objects that may suffer from magnetism must not be brought close to this equipment.

### 2.2.2 Requirements to personnel

	<p><b>WARNING</b>  <b>People with insufficient skills may suffer injuries.</b>            Inexpert handling may entail severe damage to persons and property.            Therefore:</p> <ul style="list-style-type: none"> <li>– Make sure that any and all activities are carried out by skilled personnel, only.</li> </ul>
---	---

- This equipment may be operated only by persons who can be relied on to do their work properly.
- Persons whose capability of reaction is impaired, e.g. by drugs, alcohol or medication, must not be allowed to handle this equipment.
- When selecting suitable operating personnel, be sure to respect occupational regulations and legislation concerning skills, age etc.

This operating manual specifically names the following types of personnel who must have the following skills:

- **Operator / welder**  
has extensive skills and experience in the field of resistance welding and with the corresponding preliminary and finishing jobs. The welder / operator has been coached / trained by employees of Elektron and/or an authorised representative / dealer of Elektron concerning his tasks and duties and possible hazards in connection with inappropriate behaviour and confirms this with his signature (see draft of training report form, "Appendix").
- **Service personnel**  
refers to manufacturer's own service personnel and/or that of his representative / dealer. Such service personnel have the professional training, skills and experience as well as knowledge of pertinent regulations to carry out the jobs they accept and to identify, avoid and prevent hazards on their own and without additional support.
- **Skilled electrician**  
has the professional training, skills and experience as well as knowledge of pertinent regulations to carry out jobs on electrical equipment and to identify, avoid and prevent hazards on his own and without additional support. A skilled electrician is needed, for instance, if the conductor cross-section and fuse protection of the operating company's power grid must be adapted to the special requirements of resistance welding.

### 2.2.3 Personal protective equipment (PPE)



#### **CAUTION ! Insufficient protection against injuries**

Defective safety clothing may not constitute a proper protection against injuries. Therefore:

- Be sure to check PPE for integrity and good working condition before you start any works.
- Replace defective PPE.
- Consider manufacturer's instructions and expiration dates, when and where applicable.

Wearing PPE during work is essential to minimise health and safety risks.

- Be sure to be always wearing the appropriate PPE for the job at hand.
- Be sure to take note of and comply with warning signs concerning PPE that may be installed at the workplace.



#### **Non-inflammable safety clothing**

is a tight-fitting sort of special clothing that is not inflammable, covers arms and legs completely and tears easily (instead of getting pulled in). Its main purpose is to protect against burns.



#### **Face screen**

protects the face and eyes against splashes, flying sparks and other hot particles.



#### **Welder's gloves**

protect the hands against splashes, flying sparks and other hot particles, and prevent contact with hot surfaces. Never use wet welder's gloves.



#### **Safety shoes**

protect the wearer's feet against falling objects, slippery surfaces and being run over by vehicles.

#### **Furthermore:**

no long hair, rings, necklaces, watches and/or other sorts of jewellery. Do not carry easily inflammable objects in your pockets (matches, lighters etc.).

## Health and safety

### 2.3 Particular dangers

#### 2.3.1 Dangers due to the equipment

##### Electricity



##### **DANGER ! Electricity constitutes a danger to life and limb.**

Touching live components can result in a fatal electrical shock. Therefore:

- As soon as you notice any damage to insulation, disconnect the power supply and have the damage repaired.
- Do not open this equipment yourself. Have all repairs carried out by service personnel, exclusively. Have works on electrical equipment carried out by skilled electricians, exclusively.
- Before any and all electrical works: disconnect power, earth and short. Check whether equipment is really dead.
- Keep live components away from liquids and humidity. They may cause short circuits.
- Protect cables against running over, contact with oils, aggressive substances, tools, pointed and/or hot objects.
- When pulling from a socket: Never pull on the cable. Pull on the plug.
- Do not use the cable to trail or drag equipment over the floor. Always grab equipment by the handles provided for that purpose.
- Use strain relief clamps to protect cables.
- Make sure protective ground conductors have been connected properly.
- After disconnecting the welder from the mains the welder still contains residual current for approx. 15 minutes.

##### Electromagnetic fields



##### **DANGER! Electromagnetic fields pose a potentially fatal hazard to people with pacemakers or other magnetisable implants.**

Electromagnetic fields affect the functionality of pacemakers and other magnetisable implants. Electromagnetic fields can irritate human sense organs, nerve and muscle cells. Therefore:

- Persons with pacemakers or other magnetisable implants must not approach the work area.
- Be sure to put up suitable warning signs.
- Be sure to put warning signs on access ways and doors leading to the work area.
- Do not guide welding cables along people's heads or spines. (To comply safely with permissible exposure limits, keep distances  $\geq 20$  cm. Keep a distance of at least 1 cm between cable assemblies and people's heads / spines.)

##### Splashes, flying sparks



##### **WARNING ! Splashes and flying sparks constitute a danger of fire and explosion. Splashes and flying sparks pose a risk of injuries.**

Welding generates sparks and -hot spatter. They can ignite combustible materials and generate explosions. Contact with body parts may entail injuries. Therefore:

- Before you tackle any welding jobs, make sure there are no combustible and/or explosive materials in the work area.
- Do not carry out welding jobs in the vicinity of pressure vessels, tanks, oil barrels, paint cans and/or in a work area with an explosive atmosphere.
- Have fire extinguishing gear ready at hand.
- Make sure access and escape routes are not blocked.
- During any and all welding jobs: be sure to be wearing a face screen, non-inflammable safety clothing and welder's gloves.
- Do not carry easily inflammable objects in your pockets (matches, lighters etc.).

**Hot surfaces****CAUTION ! Hot surfaces pose a risk of burns.**

Electrodes may heat up to 80 degrees centigrade approx. Stock may have up to 100 degrees right after welding. So there is an acute risk of burning yourself. Therefore:

- Never work without proper safety clothes and gloves near hot components.
- Let freshly welded parts cool down to ambient temperature before you go on to work with them.

**Scald hazard****DANGER! Scalding may occur due to hot water coming out!**

While pulling out the cooling water hoses hot water may come out. Therefore:

- Wear gloves.
- Pull out water hoses carefully.

**Slip hazard****DANGER! Slip hazard due to water coming out!**

While pulling out the cooling water hoses water may come out. Therefore:

- Remove water from the floor.

**2.3.2 Dangers due to the work environment****Vapours****WARNING ! Vapours may constitute a danger to your health.**

Stock that has not been properly ground and cleaned before welding may be contaminated with residues of glues, paints, undercoating products etc. that may generate harmful or even toxic vapours during welding. Therefore:

- Before you tackle any welding jobs, make sure the sheets you want to weld have been properly ground and cleaned and are free of residues.
- Be sure to be wearing a face screen. Respiratory equipment may be recommendable in case of doubt.

**Stumbling hazards****WARNING ! Possibility of injuries due to stumbling and falling.**

The work environment may pose stumbling risks. Stumbling and falling may lead to severe injuries. Therefore:

- Before you tackle any welding jobs, make sure the work area is tidy and free of clutter and offers enough freedom to move.
- Install cables and supply lines in such a way that they do not constitute a stumbling trap.
- When welding, assume a safe and stable working position.

**2.3.3 Dangers to this equipment and other property****Tipping and toppling hazards due to high centre of gravity and obstacles during travel****CAUTION ! Tipping and toppling may cause damage to property.**

This equipment's centre of gravity is relatively high. In the event the wheels jam and/or block (due to an obstacle or transverse pull, for instance), there is a danger the equipment tips over. Therefore:

- Move this equipment always using the handles.
- Keep potential obstacles out of the work area.
- Install cables and supply lines in such a way that they do not constitute a stumbling trap.

## Health and safety

---

**There is a danger the equipment rolls away because the wheels must not be blocked due to the tipping and toppling hazard**



**CAUTION ! Equipment rolling away may cause damage to property.**

The wheels of the equipment must not be blocked because this would cause a tipping and toppling hazard. On the other side, though, this detail causes and increases the danger the equipment rolls away. Therefore:

- Be sure to operate this equipment only on a flat and even floor.
- Proceed with care when moving this equipment.

### Danger to control panel



**CAUTION ! Control panel may sustain damage.**

The control panel may sustain damage when being closed if negligent employees leave objects lingering on the accessory box beneath. Therefore:

- Never put objects on the accessory box beneath the control panel.
- Proceed with care when closing the flap cover with integrated control panel.

## 2.4 Correct behaviour in accidents and dangerous situations

### Preventive measures

- Be prepared to confront accidents and fires.
- Be sure to have first aid equipment (kits, blankets etc.) and fire extinguishers ready at hand.
- All personnel must know about accident signalling systems, first aid, rescue and escape equipment.
- Keep access ways for ambulances clear and open.

### Measures to be taken in case of accidents

- Turn off power switch.
- Initiate first aid.
- Evacuate people from danger zone.
- Alert persons in charge.
- Alert fire brigade and ambulance service.
- Keep access ways for ambulances clear and open.

## 2.5 Measures to be taken in case of work at the device

- De-energise.
- Secure against restarting (e. g. pull out mains plug).
- Unstressedness determine.
- Ground and short circuit.
- Neighbouring energized parts cover or provide with gates.

## 2.6 Safety devices



**WARNING! Danger! Due to insufficient protection against residual current!**

Connection to electrical socket: the device may only be plugged into a socket with a residual current device and an operable earthing device.



**Power switch**

Turning the power switch to position "0" will disconnect the power supply immediately.

Fig. 1: Power switch on the backside



**WARNING ! Danger! Equipment may still be under voltage.**

After switching off the power switch on the backside of the equipment, there may still be components inside that are still under voltage. Therefore:

- In order to disconnect this equipment from the power supply, switch off using the power switch. Earth components, short circuit and check for residual electricity.

## 2.7 Safety labels and markings on this equipment Fehler! Textmarke nicht definiert.

### 2.7.1 On the flap cover



Fig. 2: Warning sign "Electromagnetic fields" on the flap cover

**Meaning**

Welding generates electromagnetic fields. Electromagnetic fields pose a potentially fatal hazard to people with pacemakers or other magnetisable implants. Electromagnetic fields also affect magnetisable objects, like e.g. watches, smart cards etc.



**DANGER ! Electromagnetic fields pose a mortal danger to persons with pacemakers.**

Electromagnetic fields affect the functionality of pacemakers and other magnetisable implants. Electromagnetic fields can irritate human sense organs, nerve and muscle cells. Therefore:

- Persons with pacemakers or other magnetisable implants must not approach the working area.
- Be sure to put up suitable warning signs.
- Be sure to put warning signs on access ways and doors leading to the work area.
- Do not guide welding cables along people's heads or spines. Keep a distance of at least 1 cm.

## Health and safety

### 2.7.2 Signs on the backside

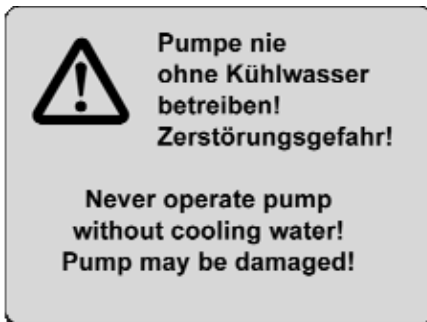

Fig. 3: Warning sign on the backside

#### Meaning

Do not operate pump without cooling water.  
Pump running dry may sustain damage.



#### CAUTION

Pump may sustain damage when running dry.  
Pump running dry may sustain damage. Therefore:

- Before starting up, check cooling water level at the level gauge.
- If necessary (i.e. if you can't see water in the level gauge), fill up. (→ See "5.2".)

### 2.7.3 On the balancer

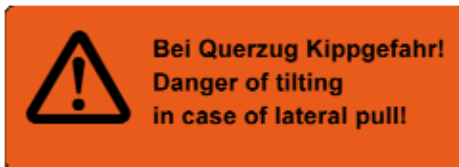

Fig. 4: Warning sign on balancer

#### Meaning

Always pull in the direction the guiding wheels are pointing.  
In the event of lateral and/or transverse pull, there is a danger the wheels jam/block and the equipment tips over.



#### CAUTION ! Tipping and toppling may cause damage to property.

This equipment's centre of gravity is relatively high. In the event the wheels jam and/or block (due to an obstacle or transverse pull, for instance), there is a danger the equipment tips over.

Therefore:

- Move this equipment always using the handles.
- Keep potential obstacles out of the work area.
- Install cables and supply lines in such a way that they do not constitute a stumbling trap.

## 2.8 Spare and wear parts



#### WARNING ! Wrong spare and wear parts constitute a hazard.

Wrong and/or defective spare and wear parts may constitute a safety hazard and may entail errors, damage and even total destruction. Therefore:

- Always use genuine spare and wear parts made by the manufacturer.

Be sure to buy your spare and wear parts directly from the manufacturer or an authorised dealer.  
For contact information →, see page 2 of this manual.

## 2.9 Waste management and environmental protection

**CAUTION ! Inexpert handling may constitute an environmental hazard.**

Inexpert handling of environmentally harmful substances, especially wrong disposal, may constitute a hazard to the environment. Therefore:

- Be sure to take appropriate measures whenever harmful substances get (or threaten to get) into the environment. In case of doubt, inform competent local authorities about the hazard or damage.
- Local authorities and specialised waste management companies will be happy to advise you with your disposal issues.
- Please also consider the following information.

**Electronic components**

Electronic components and scrap are subject to hazardous waste management and must be collected by authorised companies.

**Other components**

Unless you have concluded a return and/or disposal agreement with the manufacturer, please disassemble and recycle components.

- Scrap metals.
- Recycle plastic parts.
- Other components must be sorted by materials and disposed of accordingly.

## Transport, packaging, storage

### 3 Transport, packaging, storage

#### 3.1 Safety during transport

##### Inexpert transport



**CAUTION ! Improper transport may cause damage to property.**

Improper transport may cause damage to property. Therefore:

- When you unload packing units and move them across your premises, proceed with care. Consider symbols and information on packaging.
- Be sure to transport equipment as described hereinafter. (→ See "3.5".)

#### 3.2 Symbols on packaging

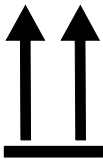

Fig. 5: Top

##### Top

The arrows point towards the 'roof' of the packing unit. This side up. The arrows must always point up, otherwise the contents of the packing unit could be damaged.



Fig. 6: Do not stack

##### Do not stack

Fragile goods. Do not stack, otherwise the contents of the packing unit could be damaged.

#### 3.3 Unpacking

1. Do not remove packaging until immediately before installation. During unpacking, do not use pointed tools.
2. Keep the original pallet (Fig. 7) in case of any further transport needs (return of goods, further transport).
3. Recycle packing materials.

##### What to do with packing materials



**CAUTION ! Improper waste disposal may cause environmental hazards.**

Packing materials are valuable raw materials. In many cases, they can be recycled, i.e. used again for packaging or in some other way or they can be further processed or treated in some way. Therefore:

- Be sure to dispose of packing materials in sustainable manner and/or according to local laws and regulations.
- Observe local waste management legislation. In case of doubt, contact a specialised company.

#### 3.4 Acceptance after shipping

Check packing units immediately after delivery. Check for integrity, missing pieces and damage.

If you detect any external shipping damage, proceed as follows:

- Do not accept delivery. Or accept under reserve.
- Report damage on carrier's shipping papers or delivery ticket.
- Initiate complaint procedure.

**NOTE!**

Be sure to register a complaint as soon as a defect has been detected. Claims for damages may be brought forward only within the deadlines set for complaints.

### 3.5 Handling

#### 3.5.1 Forklift truck

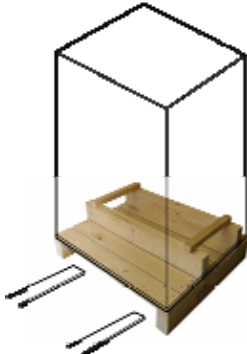

Fig. 7: Using a forklift truck

Packing units on pallets may be handled with a forklift truck, as long as the following conditions are fulfilled:

- The forklift truck must be certified for the weight of the packing unit at hand.
- The operator must have a licence to drive forklift trucks.
- Packing units may have very high centres of gravity. Make absolutely sure they cannot tip over.

**NOTE!**

Keep the original pallet in case of any further transport needs (return of goods, further transport).

#### 3.5.2 Transport with belts



Fig. 8: Transport with belts

To unload and transport use suitable device and belts.

The belts must be fixed at the handles in a way that the device cannot tip over and the belts cannot get out of place.

#### 3.5.3 Moving equipment to the site

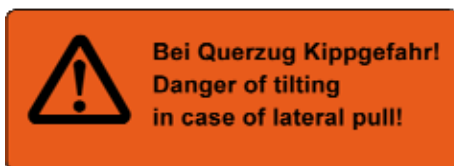

Fig. 9: Warning sign on balancer

When moving around, always grip equipment by the handle provided for that purpose.

## Transport, packaging, storage



### **CAUTION ! Tipping and toppling may cause damage to property.**

This equipment's centre of gravity is relatively high. In the event the wheels jam and/or block (due to an obstacle or transverse pull, for instance), there is a danger the equipment tips over. Therefore:

- Move this equipment always using the handles.
- Keep potential obstacles out of the work area.

**There is a danger the equipment rolls away because the wheels must not be blocked due to the tipping and toppling hazard.**



### **CAUTION ! Equipment rolling away may cause damage to property.**

The wheels of the equipment must not be blocked because this would cause a tipping and toppling hazard. On the other side, though, this detail causes and increases the danger the equipment rolls away. Therefore:

- Be sure to operate this equipment only on a flat and even floor.
- Proceed with care when moving this equipment.

## 3.6 In case of return of goods / further transport needs

1. Drain cooling water tank completely. → See "8.2.4".
2. Use original transport pallet. (See Fig. 7)
3. Use packing materials that correspond to original packing materials.
4. Mark packing materials with symbols as shown in "3.2".



### **CAUTION ! Improper transport conditions may cause damage to property.**

Packaging with inappropriate dimensions, quality or weight, or cooling water left in coolant tank may cause damage during transport. Therefore:

- Be sure to completely drain coolant tank before transport.
- Use packaging of appropriate size and quality.

## 3.7 Storage

Storage conditions:

- Do not store packing units outdoors.
- Provide for dry and dust-free storage.
- Protect against aggressive media.
- Protect against direct sun exposure.
- Protect against mechanical shocks and vibrations.
- Storage temperature: -10 to 50 degrees centigrade.-50 to 122 degrees Fahrenheit.
- Rel. humidity: 85 % max.; no dew.
- When storing equipment longer than three months, check general conditions of all parts and packaging in regular intervals. If and when necessary, refresh or renew corrosion protection.

## 4 Design and functionality

### 4.1 Overview

- 1 Running gear
- 2 Support for tools or electrode arms, for instance
- 3 Inverter control unit
- 4 Welding pliers support
- 5 Control panel
- 6 Balancer support
- 7 Balancer
- 8 Welding pliers
- 9 Handle
- 10 Welding pliers supply lines

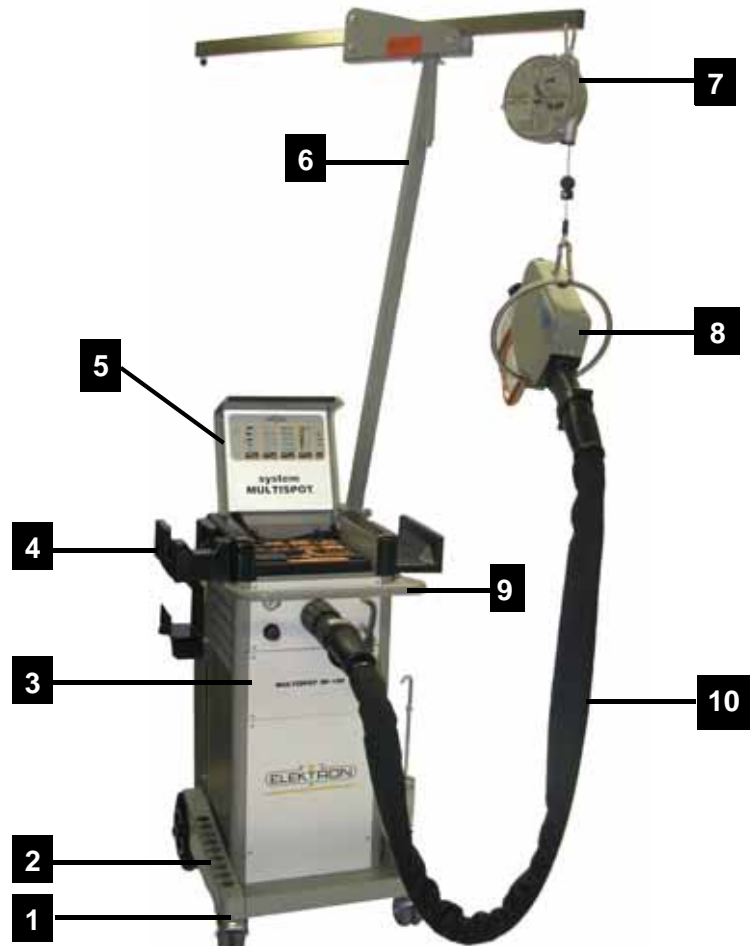

Fig. 10: Multispot system (standard)

### 4.2 Description

The **MULTISPOT MI-100** resistance welding unit is designed for special requirements for the repair and production of motor vehicle bodies. The inverter power source is controlled by a micro-processor. After selecting the operating mode, the sheet steel thickness and the welding task, the current and weld time will be assigned automatically. The current is regulated and always remains at the set level. An audible alarm is performed if the power supply is too low.

## Design and functionality

### 4.3 Display and control elements

#### 4.3.1 On the display and control panel

- 1 LED "malfunction" → see also 7.2.1
- 2 Touch key for selecting welding tool
- 3 Touch key for selecting welding gun functions
- 4 Touch key for selecting sheet gauges
- 5 Touch key for power selection

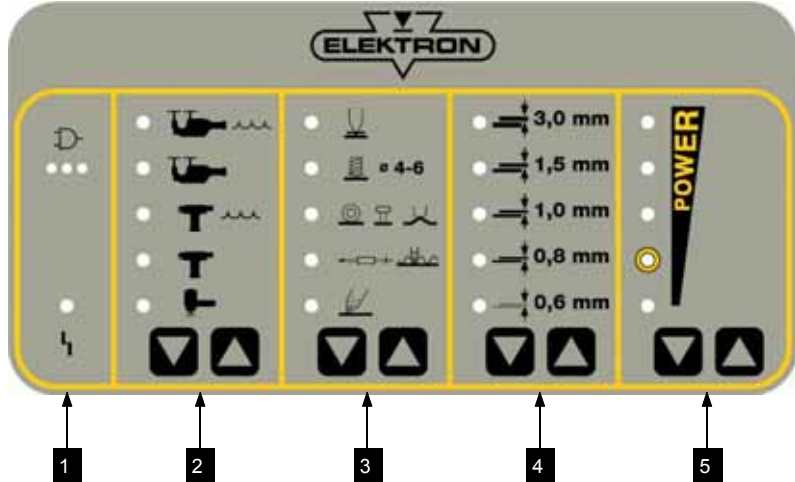

Fig. 11: Display and control panel

#### 4.3.2 On the inverter control unit



Fig. 12: Power switch (in "OFF" position)

The power switch (Fig. 12) is for switching the power supply on and off.

### 4.4 Connections

#### 4.4.1 Connections on the front side

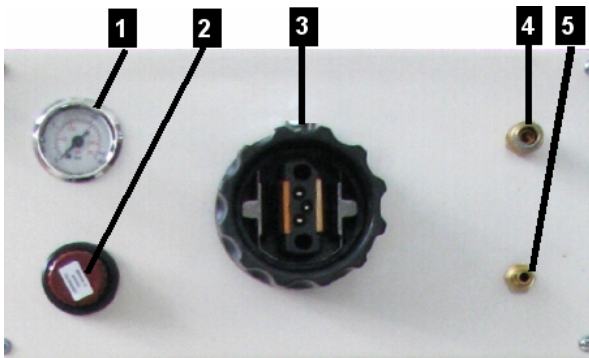

Fig. 13: Connections on the front side

- 1 Pressure gauge displays input pressure.
- 2 Pressure reducer continuous adjustment of input pressure
- 3 Central connection point for weld current, compressed air and control voltage of the welding pliers
- 4 Coolant outlet
- 5 Coolant return

4.4.2 Connections on the backside

- 1 Compressed-air filter unit
- 2 Coolant-pump air supply
- 3 Power cord
- 4 Power switch
- 5 Coolant outlet towards pump
- 6 Coolant return



Fig. 14: Connections on the backside

- 7 Water filter
- 8 Cooling-water tank cap

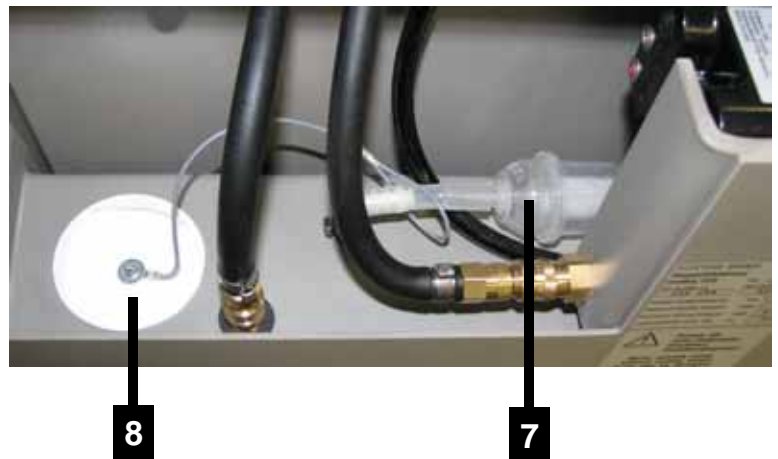

Fig. 15 :Connections on the backside

## Design and functionality

---

### 4.5 Accessories

#### 4.5.1 Scope-of-delivery accessories



Fig. 16: Water outlet hose

- Water outlet hose (Fig. 16: Water outlet hose)
- Accessory box  
(complete with a cutter for dressing electrodes and Allan key for taking off electrode arms/-hoops)
- C pliers  
(complete with set of electrodes and arms)  
or
- X pliers  
(complete with set of electrodes and arms)
- Welding gun

#### 4.5.2 Optional accessories

See catalogue for accessories

#### 4.5.3 Tools required



Fig. 17: Key for electrode caps

Key for electrode caps (Fig.17)



**NOTE!**

Find our complete range of products and order information at [www.elektron-bremen.de](http://www.elektron-bremen.de).

## 5 Installation

### 5.1 Before installation

#### 5.1.1 Preliminary works

- Check operating conditions according to specifications.  
(→ See “9”.)
- If necessary, allow equipment time to adapt to ambient temperature SLOWLY.
- Make sure that operating company’s supply systems comply with specifications.  
(→ See “9”.)
- Before you start any works, make sure the work area is tidy, clean and free of clutter and offers enough room to move.
- Make sure your tools are complete and in good working order.
- Do wear safety shoes.

### 5.2 Filling up cooling water tank

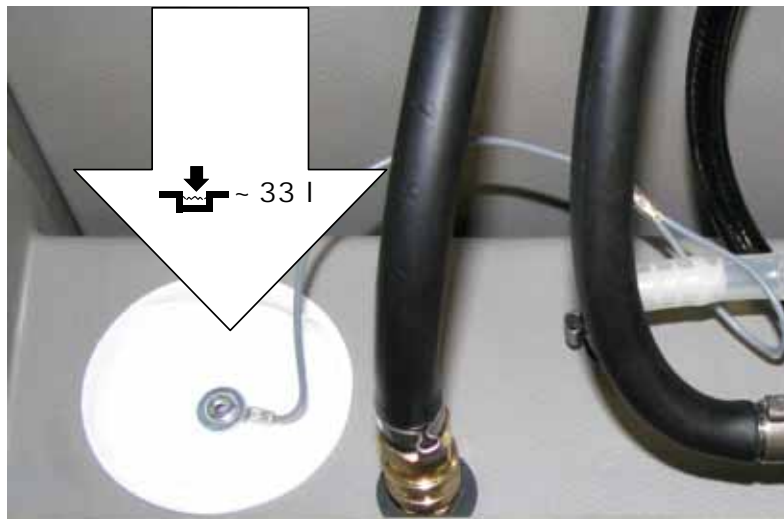

Fig.18: Filling opening

1. Twist off cap.
2. Fill about 33 litres / 9 gallons of cold, clean drinking water into the tank.
3. Add chlorine-free disinfectant to prevent growth of algae and bacteria.
4. Replace cap properly. Check for tightness.
5. Before you switch on the welder, be sure to check the level gauge beneath the filling hole.
6. Fill up, when necessary. Make sure the level is always visible in the level gauge.



**NOTE!**

For draining the tank, → see”8.2.4

## Installation

### 5.3 Assembling the balancer



Fig.19: Balancer checklist

1. Unpack the balancer.
2. Check balancer components for damage. Use the checklist provided (Fig.19) to check whether you have all the parts.
  - Balancer
  - Guide rollers with locking pin and ring
  - Vertical pipe and crossbar pipe
  - Replacement carabine hook
  - Four M8 bolts with two nuts and washers each
  - Mounting instructions

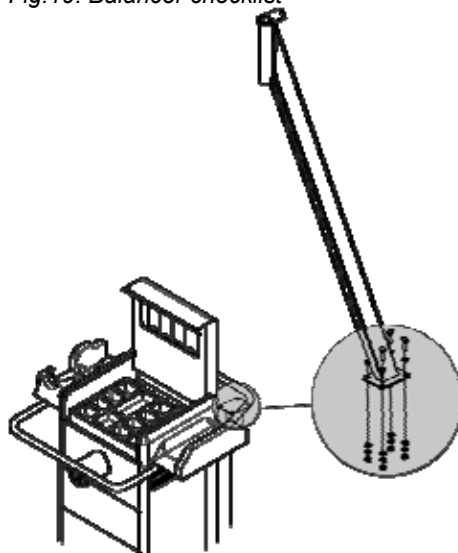

Fig.20: Vertical pipe

3. Mount the vertical pipe using four M8 bolts (Fig.20, → see separate operating and mounting instructions).

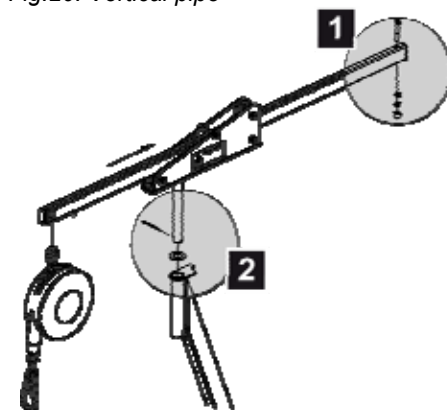
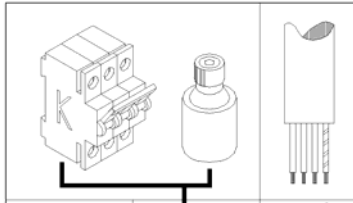

Fig.21: Crossbar pipe

4. Mount the crossbar (Fig.21, → see separate mounting instructions). Proceed as follows:
  - Mount and screw down stopper (Fig.21/1).
  - Insert crossbar pipe into guiding element. Secure with locking pin (Fig.21/2).
  - Hang up spring balancer and **secure** (see operating instructions for spring balancer).

## 5.4 Electrical connections



		mm <sup>2</sup>
400 V	35A/50A	4 x 6
230 V	63A/80A	4 x 16

Fig.22: Power grid specifications



### CAUTION

Insufficient conductor cross-sections and fuse protection may make the grid collapse and/or trigger the fuses and make efficient welding impossible.

Therefore:

- Before you connect the welder to the mains, make sure conductor cross-sections are sufficient (at least 6 mm<sup>2</sup> per 10 metres / AWG 10 per 33 ft of cable length).
- Before you connect the welder to the mains, make sure the grid is properly protected by fuses (at 32 A).



Fig.23: Connecting welder to power supply

1. Take the power cord from its support.
2. Run the power cord along a safe route.



### WARNING

#### Stumbling hazards

Power cords may constitute a stumbling hazard when improperly laid or installed and may cause people to fall and hurt themselves. In this particular case, the cable could block the wheels of the welder and make it tip over.

Therefore:

- Run the power cord along a safe route.

3. Connect the power cord to the mains.
4. Use strain relief clamps to protect cables.

## Installation

### 5.5 Connecting the pneumatics



Fig.24: Connecting compressed-air supply

1. Take the supply line from the pneumatic grid of the plant and plug it on to the welder (Fig.24).
2. The plant's pneumatic mains must provide about 8 bar (116 Psi) input pressure to the welder.



**NOTE!**

8 bar (116 Psi) input pressure generate a contact force of the electrodes of 3.5 kN (787 lb f) approx. To adjust the contact force of the electrodes, proceed as described below.



Fig.25: Pressure gauge and pressure regulator

3. Check the pressure supplied at the pressure gauge (Fig.25). If necessary, use the pressure regulator (Fig.25) to set the pressure as required (depending on welding program and manufacturer's specs).  
Turn the regulator in the "+" direction to increase the input pressure.  
**(Max. admissible: 10 bar / 145 Psi)**  
Turn the regulator in the "-" direction to decrease the input pressure.  
**(Min. admissible: 6 bar / 87 Psi)**
4. When decreasing the input pressure, actuate the pliers from time to time to let the air escape.



**CAUTION**

**Improper pressure of compressed air may damage property.**

Low pressure reduces the contact force of the electrodes which, in turn, increases wear of the electrodes. High pressure, on the other hand, may damage the spot welding pliers.

Therefore:

- Check the pressure gauge before you switch on the welder. Compare to the parameters of the welding program selected.
- Maintain the pressure between 6 and 10 bar (87 and 145 Psi).

5. Push in the regulator to set and lock the selected value.

## 5.6 Connecting the pliers



Fig.26: Connecting the pliers

1. Push the main plug of the welding pliers into the main socket of the equipment (Fig.26/1.).
2. Turn the retainer nut clockwise (Fig.26/2.) to lock the connection.

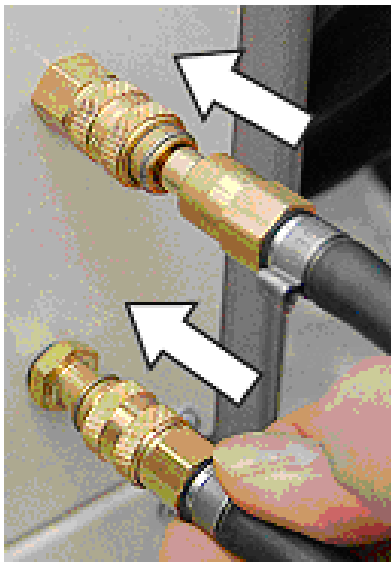

Fig.27: Water cooling system for the pliers

3. Connect the water cooling system of the pliers.

## Installation

### 5.7 Connecting the welding gun



Fig. 28. Connecting the gun

1. Push the main plug of the welding pliers into the main socket of the equipment (Fig. 28./1).
2. Turn the retainer nut clockwise (Fig. 28/2) to lock the connection
3. Unit will switch automatically and shows the “gun” symbol in the display.



Fig. 29: Copper shoe and lever clamp

4. Connect the copper shoe of the grounding cable to a bare point on the bodywork to be welded. Use lever clamp provided or a mole wrench.

**Before using the lever clamp, you have to weld on two 8 mm washers as close to the point of weld as possible, see Fig. 29 and section 6.5.2! In this case, press the copper shoe of the grounding cable firmly onto the metal sheet. This is the only way to obtain a good current transfer.**



#### Attention!

The copper shoe must always be connected to the metal sheet below the metal part of the body to be worked on. In any case avoid current transfer via hinges, door and bonnet locks, as these might otherwise be damaged! (see 6.5)

## 6 Operation

### 6.1 Preliminary works before welding

#### 6.1.1 Preparing the sheets

- Always connect the earth connection to the lower sheet. Otherwise the electricity cannot flow.
- When using insulating layers (e.g. spot welding primer), you must first establish an auxiliary connection (using a vise-grip wrench, for instance) in order to establish the electrical contact.
- Contact faces must be ground down to the bare metal on all sides.

**WARNING****Do not hurt yourself during grinding.**

Grinding sheets may constitute a hazard of injuries.

Therefore:

- Be sure to deploy employees who are experienced in this type of jobs.
  - Strictly observe any manuals etc. that come with the grinding tools.
- Galvanised sheets should not be damaged, if possible.
  - Make sure the sheets are always stacked with their faces parallel to each other. Otherwise, it will not be possible to apply clean spot welds

#### 6.1.2 Preparing welding pliers

**WARNING****Unintentional startup of welder may constitute a hazard of injuries.**

If the new tool is switched on during retooling, the weld current and/or unintentional movements of the pliers may be actuated. There is a danger of pinching and crushing.

Therefore:

- Be sure to tool up first, and only then switch on the welder.
- If retooling is unavoidable during the work, be sure to switch OFF before you do anything.

**NOTE!**

*For more detailed information on preparing / tooling up the welding pliers,  
→ see separate operating instructions.*

**CAUTION**

**Switch off cooling first before changing electrodes !**

## Operation

### Exchanging electrode arms



Fig.30: Unbolting electrode arm



Fig.31: Removing the electrode arm.

### Exchanging electrode caps



Fig.32: Exchanging electrode caps

1. To unbolt the electrode arm, use the Allen key provided for that purpose (Fig.30).

2. Remove the electrode arm simply by pulling it out. (Fig.31).
3. Insert the new electrode arm and bolt down.

1. To loosen the electrode caps, use the special key provided for that purpose (or some equivalent tool) (Fig.32).
2. Turn clockwise, otherwise the cone comes loose.
3. Put the new caps on the electrode head and press in position.



#### **NOTE!**

*The perfectly sound condition of the caps is essential for good welding results. Electrode caps must be milled (or replaced) after maximum 50 welding jobs, especially when working with high strength and/or galvanised steel.*

### Deploying the electrode arm

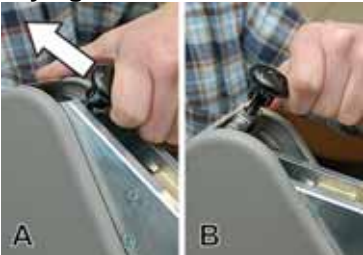

Fig.33: Unlocking the arm

### Locking the electrode arm



Fig.34: Locking the arm

1. Switch the locking device of the electrode arm from position "locked" (Fig.33/A) to position "open" (Fig.33/B) as shown in the picture.

2. Push the electrode arm without much force into the locking device until you feel and hear it engage (Fig.34).

**Adjusting the distance between electrodes**

Fig.35: Adjusting the distance between electrodes

- Make sure the distance between the electrodes is 6 to 8 mm. Carry out the first welds, and then check the distance again. Re-adjust, if necessary.
- Use an Allen key SW5 as gauge in between the tips:

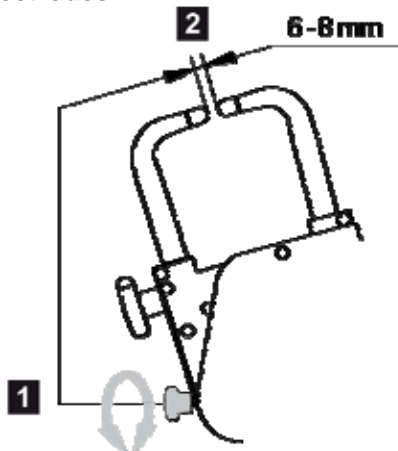

**Aligning electrodes**

Fig.36: "Electrode must be in true alignment"

- Be sure to look from different angles. Electrodes must align no matter how you look.

**6.1.3 Checks before switching on**

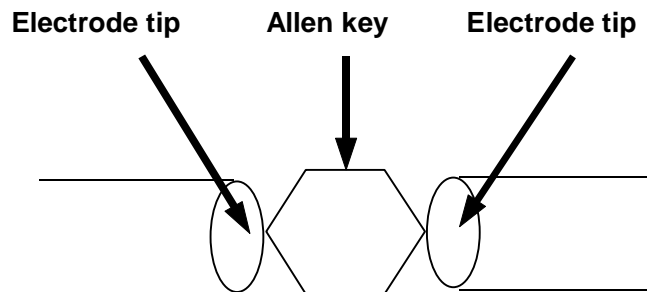
**WARNING ! Unskilled employees may hurt themselves and others. Inexpert operation constitutes a hazard of injuries.**

Inexpert and/or negligent handling of this equipment and/or ignorance of hazards and dangers may entail the most severe injuries. Therefore:

- Make sure this equipment is put to use by skilled welding operators with sufficient training and experience in spot welding, exclusively.
- Before operation, consult the manual and make sure any and all preconditions are fulfilled, any and all checks and preliminary works etc. have been carried out.
- Work place must be clean and tidy – no clutter. Make sure you have enough room to move.

- Be sure to be wearing adequate PPE. (→ See "2.2.3".)
- Check any and all connections. (→ See "5".)
- Check input pressure. (→ See "5.5".)
- Check cooling water level. (→ See "5.2".)
- Check your tools / welding pliers). Re-tool now, if necessary. (→ See "6.1.2" and/or separate operating instructions for welding pliers.)

## Operation

### 6.2 Switching on



Fig. 37: Power switch

1. Once the welder has been installed and prepared according to instructions, you may switch it on by turning the power switch (Fig. 37).

### 6.3 Bedienung über Tastatur

- 1 LED "malfunction" → see also 7.2.1
- 2 Touch key for selecting welding tool
- 3 Touch key for selecting welding gun functions
- 4 Touch key for selecting sheet gauges
- 5 Touch key for power selection

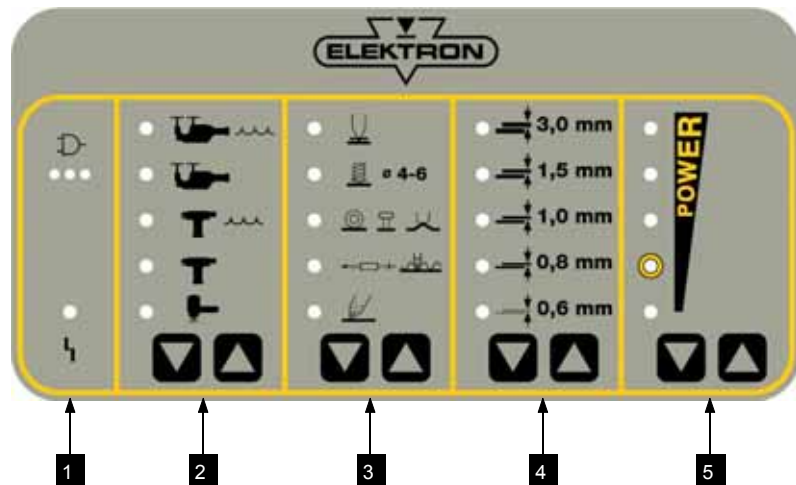

Fig. 38: Control panel

## 6.4 Important information concerning welding

### Electromagnetic fields

**DANGER**

**Electromagnetic fields pose a potentially fatal hazard to people with pacemakers or other magnetisable implants.**

Electromagnetic fields affect the functionality of pacemakers and other magnetisable implants. Electromagnetic fields can irritate human sense organs, nerve and muscle cells. Therefore:

- Persons with pacemakers or other magnetisable implants must not approach the working area.
- Be sure to put up suitable warning signs.
- Be sure to put warning signs on access ways and doors leading to the work area.
- Do not guide welding cables along people's heads or spines. Keep a distance of at least 1cm.

### Splashes, flying sparks

**WARNING**

**Splashes and flying sparks constitute a danger of fire and explosion. Splashes and flying sparks pose a risk of injuries.**

Welding generates sparks and –hot spatter. They can ignite combustible materials and generate explosions. Contact with body parts may entail injuries. Therefore:

- Before you tackle any welding jobs, make sure there are no combustible and/or explosive materials in the work area.
- Do not carry out welding jobs in the vicinity of pressure vessels, tanks, oil barrels, paint cans and/or in a work area with an explosive atmosphere.
- Have fire extinguishing gear ready at hand.
- Make sure access and escape routes are not blocked.
- During any and all welding jobs: be sure to be wearing a face screen, non-inflammable safety clothing and welder's gloves.
- Do not carry easily inflammable objects in your pockets (matches, lighters etc.).

### Vapours

**WARNING !Vapours may constitute a danger to your health.**

Stock that has not been properly ground and cleaned before welding may be contaminated with residues of glues, paints, undercoating products etc. that may generate harmful or even toxic vapours during welding. Therefore:

- Before you tackle any welding jobs, make sure the sheets you want to weld have been properly ground and cleaned and are free of residues.
- Be sure to be wearing a face screen. Respiratory equipment may be recommendable in case of doubt.

### Hot surfaces

**CAUTION ! Hot surfaces pose a risk of burns.**

Electrodes may heat up to 80 degrees centigrade approx. Stock may have up to 100 degrees right after welding. So there is an acute risk of burning yourself. Therefore:

- Never work without proper safety clothes and gloves near hot components.
- Let freshly welded parts cool down to ambient temperature before you go on to work with them.

## Operation

### Tipping and toppling hazards due to high centre of gravity and obstacles during travel



**CAUTION ! Tipping and toppling may cause damage to property.**

This equipment's centre of gravity is relatively high. In the event the wheels jam and/or block (due to an obstacle or transverse pull, for instance), there is a danger the equipment tips over. Therefore:

- Move this equipment always using the handles.
- Keep potential obstacles out of the work area.
- Install cables and supply lines in such a way that they do not constitute a stumbling trap.

### There is a danger the equipment rolls away because the wheels must not be blocked due to the tipping and toppling hazard



**CAUTION ! Equipment rolling away may cause damage to property.**

The wheels of the equipment must not be blocked because this would cause a tipping and toppling hazard. On the other side, though, this detail causes and increases the danger the equipment rolls away. Therefore:

- Be sure to operate this equipment only on a flat and even floor.
- Proceed with care when moving this equipment.

### Personal protective equipment (PPE)



**Non-inflammable safety clothing**

is a tight-fitting sort of special clothing that is not inflammable, covers arms and legs completely and tears easily (instead of getting pulled in). Its main purpose is to protect against burns.



**Face screen**

protects the face and eyes against splashes, flying sparks and other hot particles.



**Welder's gloves**

protect the hands against splashes, flying sparks and other hot particles, and prevent contact with hot surfaces.



**Safety shoes**

protect the wearer's feet against falling objects, slippery surfaces and being run over by vehicles.

**Furthermore:**

no long hair, rings, necklaces, watches and/or other sorts of jewellery. Do not carry easily inflammable objects in your pockets (matches, lighters etc.).

- Be sure to be always wearing the appropriate PPE for the job at hand.
- Be sure to take note of and comply with warning signs concerning PPE that may be installed at the workplace.

**Adjusting the contact force**

**NOTE!**

Be sure to set the correct contact force with respect to the current welding because:

- If the contact force of the electrodes is too high, the electrical resistance will be too weak which, in turn, will affect the welding job.
- If the contact force is too weak, the welding spots may erode and leave holes in the sheets.



Fig.39: Contact force  $\leq 1.8$  kN

**CAUTION**
**Danger to property.**

When using the electrode arm configuration shown to the left, 12-mm electrodes will slightly bend if the contact force is set higher than 1.8 kN (405 lb f).

Therefore:

- Ask yourself, whether the job at hand could be handled just as well with a different configuration.
- When you have to use the configuration as shown here, make sure the contact force does not exceed 1.8 kN (405 lb f) / 6 bar (87 Psi).

**Distances between welding spots**

Fig.40: "Distances should not be too short."

- Don't keep the distances between welding spots too short (25 mm approx.). Otherwise, the weld current might affect the spots (that have already been applied) a second time.

**Lifetimes of electrode caps**

**NOTE!**

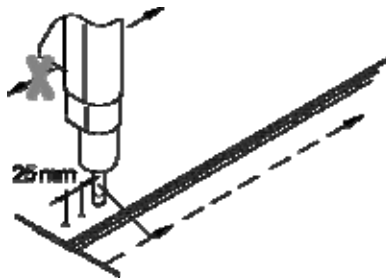
The perfectly sound condition of the caps is essential for good welding results.

Electrode caps must be milled (or replaced) after 50 welding jobs, especially when working with high strength and/or galvanised steel (→ see "0").

## Operation

### 6.5 Operating the welding gun

#### 6.5.1 Push spot welding



**Caution!**  
**Electromagnetic fields! Wear protective goggles and gloves!**  
**Electrodes heat up! Flying sparks!**



**Only use the mode "push spot welding" is the area to be welded cannot be reached with the spot welding pliers!**

1. Grind sheet surface and the area between the sheets until completely bare.
2. In the welding area the sheets must have direct contact without air gap. Otherwise welding is impossible.
3. Check the condition of welding electrodes and grind them, if necessary.
4. Ensure perfect earthing to bottom sheet as close to the welding spot as possible.
5. Select mode "push spot welding" and sheet thickness on display (thickness of more than 1.5 mm cannot be selected!).
6. Press the welding gun to the welding point with a pressure of approx. **8 –12 kgs**.

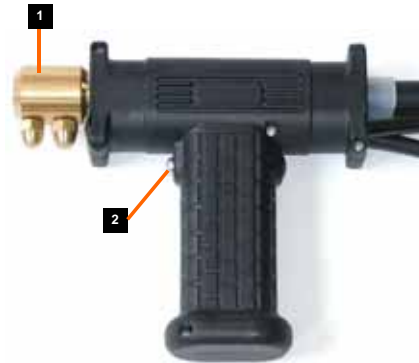

Fig. 41: welding gun  
 contact piece (1) / release button (2)

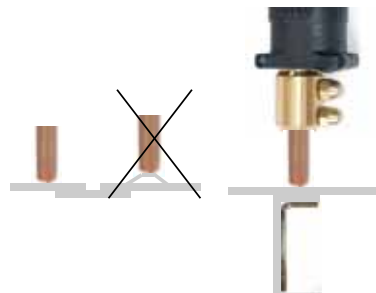

Fig. 42: Pressure on welding point



**NOTE!**

*Excessive contact pressure will lead to poor welding results when the distance to the ground connection is too great.*



**Inadequate contact pressure – air gap or paint (grease) between the steel sheets – will result in the upper sheet being burnt through and the electrode cap destroyed.**

The air cooling for the spot gun is activated for approx. 15 sec. after the first spot. When the gun is hot, the cooling runs continuously until the gun has cooled down to approx. 40°C.

**Do not switch the unit off during the cooling phase to prevent any heat congestion.**

- Keep hold of release button of the gun until welding process has ended.



**Always spot-weld thinner sheets to thicker ones!**

Proceed with welding towards the grounding point.

Spacing between the welding spots approx. 20 mm.

### 6.5.2 Pulling-out dents with washer

1. Grind the damaged area to a bright metal finish.
2. Insert contact piece (Fig. 43) into welding gun.
3. Select "washer" mode and sheet thickness on display. (Sheet steel thickness more than  $2 \times 1.5 = 3$  mm cannot be selected).  
Fine-adjust +/-.
4. Position welding gun with washer in the area of the dent.
5. Press release button of the gun.
6. Hook pulling tool into the washer (Fig. 44) and carefully beat out the dent.
7. Remove washer by twisting. Only twist the washer off, otherwise holes in the sheet steel could result.



Fig. 43: contact piece UB



Fig. 44: Pulling tool



**Note !**

*8 mm Washer. Always beat out major dents from the outside, working inwards.  
Use bright washers instead of galvanized.  
Adjust setting on display according to size and type of the dent, if necessary.*

## Operation

### 6.5.3 High-speed planishing hammer „SAH“ (special accessory)

Small dents, scratches or hail pitting can easily be removed with the high-speed planishing hammer (42).

1. Grind damaged area to a bright metal finish.
2. Insert high-speed planishing hammer (Fig. 45) (with weld on tip) into the gun.
3. Select "SAH" mode and sheet thickness on display (Sheet steel thickness above 0.8 mm cannot be selected). Fine-adjust +/-, if necessary.
4. Position weld-on tip of the hammer in the damaged area.
5. Press release button of the gun and weld-on welding tip.
6. Beat out the dent.
7. Twist the high-speed planishing hammer (SAH) off the sheet steel. Select the weld time as short as possible.
8. From time to time, dress the weld-on tip with a file.



Fig. 45: High speed planishing hammer, SAH' (special accessory)



**NOTE!**

Repeat the procedure until the damaged area is entirely repaired.



**CAUTION!** Heavy dents only remove with extractor tool and 8mm washer, as otherwise the welding gun might be damaged!



**NOTE!**

If the weld-on tip is worn out, it should be replaced. For replacement unscrew the socket-head cap screw at the top of the hammer (SAH) and remove the worn out weld-on tip. Position new weld-on tip and properly tighten socket-head capscrew!

For item number please see spare parts list.

#### 6.5.4 Pushing-in dents

Small high spots dents caused by overlapping load in the boot or by beating out with pulling tool can easily be flattened with contact piece (only for sheets up to 1 mm thickness).

1. Insert contact piece (Fig. 46) into the gun.
2. Select "pushing in dent" and sheet thickness ( $\approx$  projection) on display.
3. Fine-adjust, if necessary.
4. Position welding gun with contact piece on the dent and press firmly.
5. Press release button of the gun.
6. The welding program performs automatically.



Fig. 46: contact piece U-B



**NOTE!**

*Do not lift off welding gun until the welding time has expired*

#### 6.5.5 Shrinking sheet

1. Grind damaged area to a bright metal finish.
2. Insert carbon electrode (Fig. 47) into contact piece of the welding gun.
3. Select "anneal/shrink" on display (time controller is now inoperative).
4. Locate the damaged area by finger pressure.
5. Position carbon electrode (39) in the centre of the damaged area.
6. Press and keep hold of release button of the gun and heat the metal sheet with spiral motions from the centre outwards.
7. Immediately quench the sheet with a wet cloth or compressed air.

Repeat if necessary.

If necessary, the degree of annealing can be increased or decreased on the display (sheet gauge) by one level up or down.



Fig. 47: carbon electrode



**Danger!**

**The carbon electrode becomes red-hot! Danger of injury and fire!  
Wear protective gloves!**

## Operation

---

### 6.5.6 Welding-on threaded studs

With the MULTISPOT MI-100 it is possible to weld on threaded studs of 4, 5, 6 mm diameter. Please use the appropriate contact pieces (SB 4 for Ø 4 mm/ SB 5 for Ø 5 mm/SB 6 for Ø 6 mm)

1. Insert appropriate contact piece (Fig. 48) into welding gun.
2. Insert threaded stud into contact piece until limit stop.
3. Select "weld on studs" mode and sheet thickness on display.
4. Decrease power by one step for studs of 4 mm Ø.
5. Increase power by one step for studs of 6 mm Ø.
6. Position welding gun with the stud at the welding point and press slightly.
7. Press and keep hold of release button of the gun until welding program has ended.



Fig. 48: Contact piece "threaded stud"

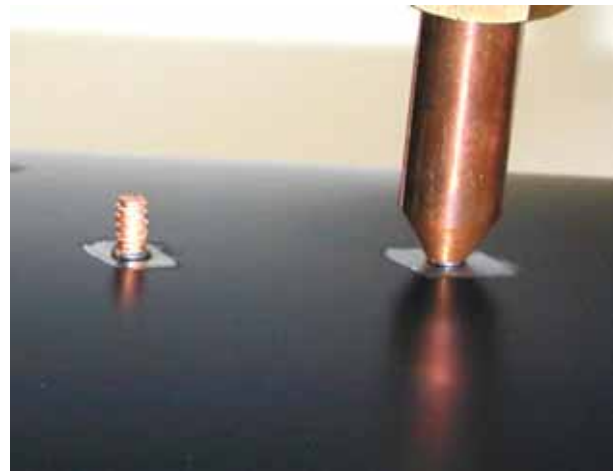

Threaded studs without collar can also be welded on. Use a nut in place of a collar. The part to be welded should project from the nut about 1 to 2 mm. Welding procedure as described above.

### 6.5.7 Welding-on T-pins

For example T-pins used for fixing trim strips, can be welded on using contact pieces TST 3 (1) and TST 5 (7). Incorporated in the tip of the contact piece is a magnet which holds the T-pin during the welding process.

**NOTE!**

*Special fittings are available for welding works on roof areas of the vehicle types Golf 2, Golf 3, Vento, Porsche 944 and Passat B3. These fittings permit accurate welding on of the T-pins exactly at the points specified by the vehicle manufacturers.  
For item numbers please see accessories list!*

**Welding procedure:**

1. Grind welding area to a bright metal finish.
2. Select appropriate contact piece and insert until limit stop into welding gun.
3. Select "T-pin" mode and sheet thickness on display.
4. Insert head of T-pin into tip of contact piece.
5. Select welding position and press-on welding gun.
6. Press and keep hold of release button of gun until end of welding program.



Fig. 49: Contact piece

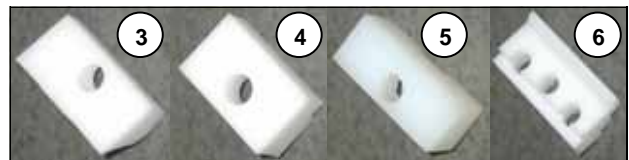

Fig. 50: Fitting piece

1	Contact piece TST 3	Art.-Nr. 407 227	
2	T-pin 3 x 4,5	Art.-Nr. 408 597	
3	Fitting piece Golf 2	Art.-Nr. 313 451	Special accessory!
4	Fitting piece Passat B 3	Art.-Nr. 315 671	Special accessory!
5	Fitting piece Porsche	Art.-Nr. 314 465	Special accessory!
6	Fitting piece Golf 3 / Vento	Art.-Nr. 317 962	Special accessory!
7	Contact piece TST 5	Art.-Nr. 408 540	Special accessory!
8	T-pin 5 x 10	Art.-Nr. 408 571	Special accessory!

**NOTE!**

*T-pins of  $\varnothing$  5 x 10 (8) can be welded on using contact piece TST5 (7).*

- *Select "stud welding" and sheet thickness on display.*
- *Fine-adjust, if necessary.*

*Otherwise, proceed as described above.*

## Operation

### 6.5.8 Fixing sheet metal parts (tacking)

Body sections frequently have to be fixed temporarily for the purpose of alignment. In some areas, clamps cannot be used. In such cases, the sections can be fixed by tack welding with the MULTISPOT MI-100. Washers from which  $\frac{1}{4}$  has been cut out can be used as fixing aid.

1. Insert contact piece for washers into welding gun to limit stop.
2. Cut off approx.  $\frac{1}{4}$  of a washer of 8 mm  $\varnothing$  with a side cutter.
3. Insert prepared washer into contact piece.
4. Select "washer weld" and sheet thickness on display.
5. Position the washer and press-on.
6. Press and keep hold of release button of the gun until end of automatic welding program.

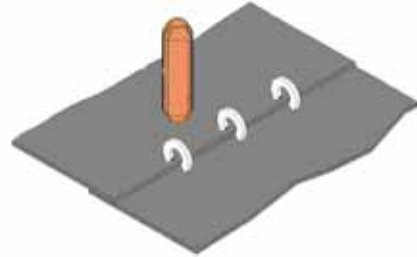

Fig. 51: contact piece

### 6.5.9 Water-cooled spot welding gun (special accessory)

The water-cooled spot welding gun can only be used for one-sided spot welding (push spots)!

1. Insert spot welding gun in the central socket of the welder unit. (Unit changes over automatically to the right gun symbol).
2. Connect the cooling water feed pipe and return pipe to the corresponding connections of the welder unit.
3. Clamp the copper ground lug to the body.

**Caution:** ensure there is good current conduction!

4. Proceed with spot welding as described in 6.5.1
5. Instead of the ground lug, a second gun can be connected (switch welder unit off first and wait until cooling pump switches off automatically) so that 2 spot welds can be carried out at once. This is useful, if the ground lug cannot be fitted. The welding procedure can only be triggered with one gun.
6. After finishing the welding task, let the cooling pump run on for a while to prevent heat congestion.

### 6.5.10 Connection of Airpuller/ Dentpuller

Connect Airpuller / Dentpuller to central socket of the welder unit.

The unit will switch automatically to the "Special" symbol on the control panel.

In "planishing" mode select sheet thickness (up to a max. of 2 x 1 mm) on control panel.



**NOTE!**

- Fine-adjust on display, if necessary.
- Operating the Airpuller please see operating instructions

## 7 Troubleshooting

### 7.1 Health and safety during troubleshooting

**WARNING**

**People with insufficient skills may suffer injuries.**

If you carry out troubleshooting and repairs yourself, you may encounter certain risks and hazards that may entail severe injuries. Therefore:

- Do not open the welder. Do not modify the welder. Do not try to carry out repairs yourself.
- For any and all troubleshooting measures not explicitly mentioned and/or described in this manual, you should call service personnel and/or contact the manufacturer.
- Be sure to adhere strictly to the hierarchy of responsibilities defined in the table.
- When you're in doubt: do contact service personnel / manufacturer.
- If a damage does occur: minimise, contain and avert consequential damage.

**NOTE!**

*In the event that problems occur more frequently due to above-average workloads, you must adapt the inspection and maintenance intervals accordingly.*

### 7.2 Error messages and troubleshooting tables

#### 7.2.1 Problems displayed on the control panel

Error	Possible cause	Remedy	WHO should do it?
Welder does not switch on.	Power cord not plugged in.	Plug in power cord.	Operator
	If the power cord is, indeed, connected, a mains fuse may have been triggered.	Reset fuse.	
Red LED is flashing.	Tool error.	Let the tool cool off or exchange tool.	Operator
	Mains disturbance.	Check fuses.	
Green/yellow LED is flashing	Mains disturbance.	Within tolerance range.	Operator
Yellow LED is flashing	Significant mains disturbance	Check supply lines.	Electrician

#### 7.2.2 Possible causes and remedies in case of unsatisfactory welding results

Symptom	Possible cause	Remedy	WHO should do it?
Weld spot too small	Weld current too weak.	Adapt welding parameters.	Operator
Welding spot burns up, excessive spattering, sheets not strong enough	Weld current too high.	Adapt welding parameters.	Operator
Welding insufficient	Sheets may have been insufficiently prepared.	→ "6.1.1"	Operator

## Maintenance

### 8 Maintenance

#### 8.1 Maintenance schedule

Intervals	What must be done?	WHO should do it?
<b>Before ANY maintenance job</b>	Visually check the welder and its periphery for damage, dirt, contamination etc. Clean, if necessary (→ see “8.2”).	Operator
	Check connections for tight fit. (→ See “5.4” – “5.6”).	
	Check compressed-air supply. (→ see “5.5”)	
	Check level gauge. Cooling water level okay? Fill up, if necessary. (→ See “5.2”).	
	Visually check electrode caps. If necessary, clean, mill and/or replace. (→ See “6.1.2”).	
	Check distance and –alignment of electrodes. (→ See “6.1.2”).	
<b>Every 6 months</b>	Check PPE for functionality. Replace, if and as soon as necessary.	Operator
	Check purity and quality of operating company’s compressed-air supply.	
	Check the work environment. Does it still fulfil all the operating requirements? (→ See “9Fehler! Verweisquelle konnte nicht gefunden werden.”.)	Operator
<b>Whenever necessary</b>	Check actual input current and voltage. Take your own measurements.	Skilled electrician
	Visually check the water separator and air filter of the pneumatic unit. Carry out jobs as required. (→ See “8.2.2”).	Operator
	Visually check the water filter. Replace, if necessary. (→ See “8.2.3”).	
Empty cooling water tank (→ see “8.2.4”). Refill (→ see “5.2”).		

#### 8.2 Carrying out maintenance jobs

##### Personnel

The maintenance jobs described here may be carried out by operators, if not explicitly stated otherwise.

- Have works on electrical equipment carried out by skilled electricians, exclusively.

### 8.2.1 Cleaning

**CAUTION**

Failure to carry out and/or negligent or improper cleaning jobs may entail damage to property.

If you do not clean the welder at all or use aggressive cleaning agents or –methods, there is a danger of damage to property.

Therefore:

- Do not use aggressive cleaning agents and/or –methods.
- Do not use steam cleaners and/or pressure washers.
- Be particularly careful with the display.
- Be sure to clean the welder on a regular schedule, especially around air vents. Adequate dissipation of heat must be ensured.

- Clean the welder with a dry, lint-free cloth. For persistent dirt, use a textile cloth that has been slightly damped with a mild detergent.
- As for the display: just dust. Be careful not to scratch the display.

### 8.2.2 Maintaining the pneumatic unit

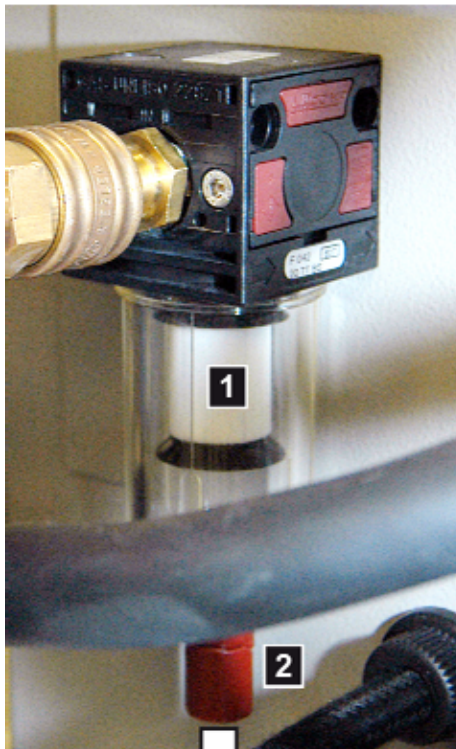

1. Visually check the compressed-air filter (Fig.52/1). Replace, when you see any accumulation of dirt.
2. Visually check the water separator (Fig.52/2) under the compressed-air filter for residues of water. If you find any accumulations of water, pull of the cap in the direction indicated by the arrow and empty water from the separator.

Fig.52: Pneumatic unit

## Maintenance

### 8.2.3 Replacing water filter

#### Scald hazard



**DANGER! Scalding may occur due to hot water coming out!**

While pulling out the cooling water hoses hot water may come out. Therefore:

- Wear gloves.
- Pull out water hoses carefully.

#### Slip hazard



**DANGER! Slip hazard due to water coming out!**

While pulling out the cooling water hoses water may come out. Therefore:

- Remove water from the floor.

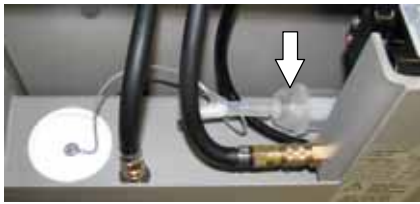

Fig.53: Water filter

1. Visually check the water filter (Fig.53).



Fig. 54: Unlocking supply

**If you detect clear signs of dirt:**

2. Switch off the welder. Wait, until the pump stops pumping.
3. Separate the cooling water supply from the pump (Fig. 54/Fig. 55/Fig. 56).
4. Pull the water filter unit from the hoses to the left and right. However, do not loosen the hose clips.
5. Replace the old filter with a new one.
6. Insert the new water filter between the hoses.
7. Re-connect the cooling water supply to the pump and lock it.



Fig. 55:Unlocking supply



Fig. 56: Water filter loosened

### 8.2.4 Empty cooling water tank

#### Scald hazard

**DANGER! Scalding may occur due to hot water coming out!**

While pulling out the cooling water hoses hot water may come out. Therefore:

- Wear gloves.
- Pull out water hoses carefully.

#### Slip hazard

**DANGER! Slip hazard due to water coming out!**

While pulling out the cooling water hoses water may come out. Therefore:

- Remove water from the floor.



Fig.57: Draining cooling water.

1. Connect the drain hose to the cooling outlet (Fig.57).
2. Have four 10-litre buckets ready at hand to catch the cooling water.
3. Do one weld without sheet by pushing the trigger of the welding pliers once. Cooling water will be drained.
4. Turn off the power switch to turn off the pump.

### 8.3 Measures to be taken after maintenance

When you finish maintenance and before you switch the welder back on, carry out the following:

1. Re-establish any and all connections you loosened and/or removed before. Check for tight fit.
2. Make sure any and all safety devices, covers etc. you may have removed are properly back in place.
3. Make sure you have properly removed and taken away from the work area any and all tools, materials etc. you may have used.
4. Clean the work area. If there have been any leaks, spills etc., clean up.

## Specifications

### 9 Specifications

#### 9.1 Dimensions and weights

Item	Value	Unit
Height	925 / 36	mm / in
Width	650 / 26	mm / in
Depth	645 / 25	mm / in
Weight (w/o accessories)	100 / 220	Kg / lb

#### 9.2 Power requirements

##### Power supply

Item	Value	Unit	Value	Unit
Mains voltage	400 / 3 ~ / 50/60	V / Ph / Hz	230 / 3 ~ / 50/60	V / Ph / Hz
Admissible voltage range	380 – 415	V (AC)	208 - 240	V (AC)
Power cord	6 AWG 10	mm <sup>2</sup> / 10 m / 33 ft	16 AWG 6	mm <sup>2</sup> / 10 m / 33 ft
Mains fuse, min.	32	A träge	63	A träge
Installed power	42	kVA	42	kVA
Rated output at 50% duty cycle	60	kVA	60	kVA
No load voltage, max.	23	V (DC)	23	V (DC)
weld current, regulated.	12000	A (DC)	12000	A (DC)
Enclosure	IP21		IP21	

##### Compressed-air supply

Item	Value	Unit
Operating pressure, min. – max.	6 – 10 87 – 145	bar Psi
Quality	clean, dry, free of oil	

#### 9.3 Supplies

Item	Value	Unit
Cooling water – tank capacity	33 / 9	l / gal
Chlorine-free disinfectant	accor.	dosing instructions

#### 9.4 Working conditions

##### Ambient conditions

Item	Value	Unit
Ambient temperature, max..	40 / 104	°C / °F
Rel Humidity, max. (no dew)	85	%

## 9.5 Exposure limit values

### Welding pliers

Item	Compliance
Exposure limit values accor. EU directive 2004/40/EC	Safe compliance with distances ≥ 15 cm perpendicular to pliers opening Safe compliance with distances ≥ 7 cm to welding cable

## 9.6 Type plates

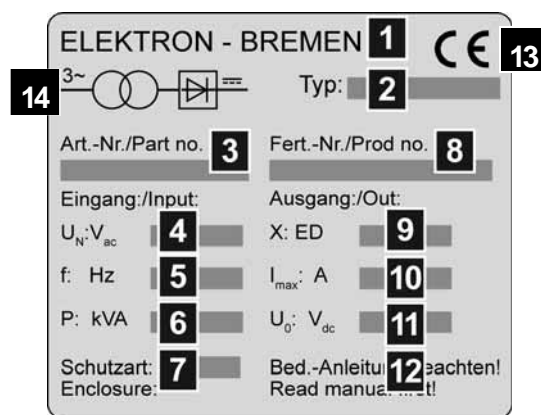

Fig.58: Type plate on the backside

- 1 Manufacturer
- 2 Inverter type
- 3 Item no.
- 4 Input voltage (in VAC)
- 5 Frequency (in Hz)
- 6 Power consumption (in kVA)
- 7 Enclosure
- 8 Production no.
- 9 Duty cycle (in %)
- 10 Max. current (in A)
- 11 Output voltage (in VDC)
- 12 Appeal: Read operating manual. Comply with operating manual.
- 13 Sign of confirmity
- 14 Block circuit diagram

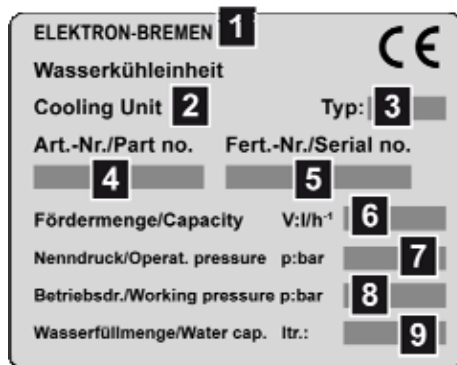

Fig.59: Type plate on water cooling unit

- 1 Manufacturer
- 2 Designation
- 3 Type
- 4 Item no.
- 5 Production no.
- 6 Flow rate in l/h<sup>-1</sup>
- 7 Rated pressure in bar
- 8 Operating pressure in bar
- 9 Volume in l

## Index

---

### 10 Index

<b>A</b>	
Accessories.....	22
Adjusting the distance between electrodes .....	31
Airpuller.....	42
Ambient conditions .....	48
Appendix.....	52
Assembling the balancer .....	24
<b>C</b>	
Chlorine-free disinfectant.....	48
Cleaning.....	45
Compressed-air supply.....	48
Connecting welding gun .....	28
Connections.....	20
electrical .....	25
pliers.....	27
pneumatics.....	26
Contact force.....	35
Contact person.....	6
Control elements.....	20
Control panel.....	20
Copyright.....	5
Customer service .....	6
<b>D</b>	
Dentpuller.....	42
Description.....	13
Dimensions and weights.....	48
Disinfection .....	23
Display and control elements.....	20
<b>E</b>	
Electromagnetic fields.....	10, 33
Empty cooling water tank.....	47
Environmental protection .....	15
Error messages.....	43
<b>F</b>	
Filling up cooling water tank .....	23
Further transport needs .....	18
<b>G</b>	
Guarantee.....	6
<b>H</b>	
Handling.....	17
<b>I</b>	
Intended purpose.....	7
Intended use .....	7
Inverter control unit .....	20
<b>L</b>	
Liability .....	6
<b>M</b>	
Maintaining the pneumatic unit.....	45
Maintenance schedule.....	44
Messages displayed on the control panel.....	43
Misuse.....	7
<b>O</b>	
Overview .....	19
<b>P</b>	
Personnel.....	8
maintenance .....	44
Power supply.....	48
Power switch.....	13
PPE.....	9, 34
Preparing the sheets.....	29
Preparing welding pliers.....	29
Problems	
welding flaws .....	43
Push spot welding.....	36
Pushing-in dents .....	39
<b>R</b>	
Replacing water filter .....	46
Responsibilities of the operating company .....	7
Return of goods.....	18
<b>S</b>	
Safety devices.....	13
Safety labels and markings.....	13
Service .....	6
Settings	
contact force .....	35
Shrinking sheet .....	39
Spare and wear parts.....	14
Specifications .....	48
spring balancer.....	24
Storage.....	18
Supplies .....	48

---

Switching on .....	32	T-pins .....	41
Symbols		Training Report .....	52
on equipment .....	13	Troubleshooting .....	43
to be installed by operating company .....	8	Type plates .....	49
Symbols on packaging .....	16	<b>W</b>	
Symbols used in the operating manual .....	5	washer .....	37
<b>T</b>		Waste management.....	15
tacking .....	42	Working conditions .....	48
threaded studs .....	40		

